

へ



しま



く



え



ひらがなを なぞろう

(

がっ)

にち

なまえ)

)

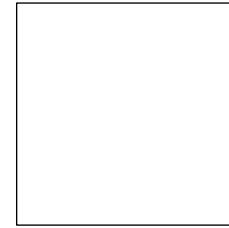
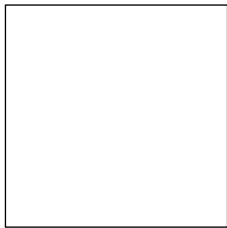
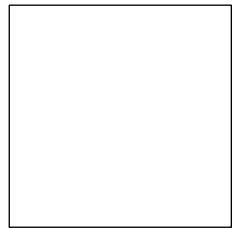
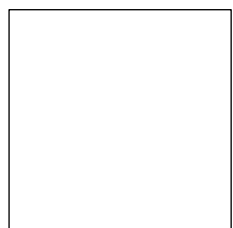
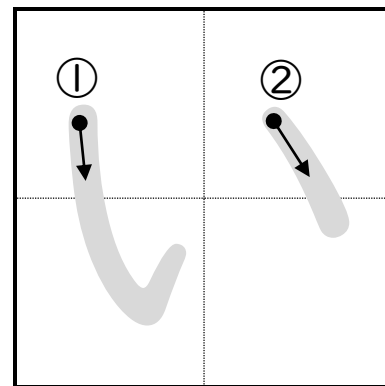
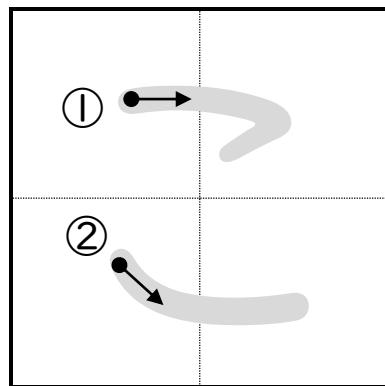
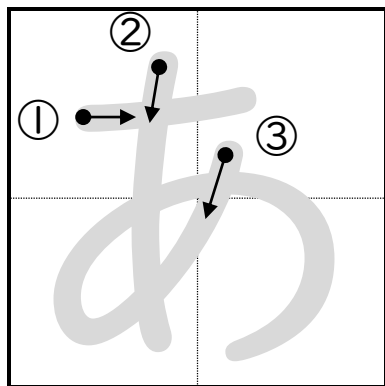
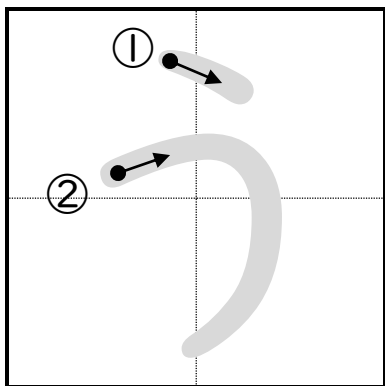

ち
わ

め

ま

す



ひらがなを なぞろう

(

がっ)

にち

なまえ)

)

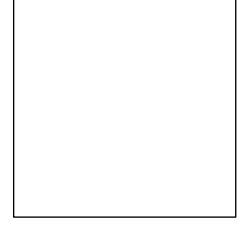
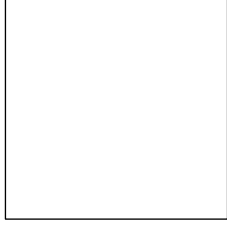
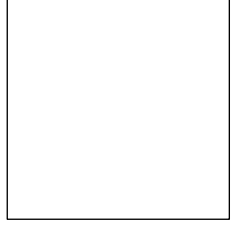
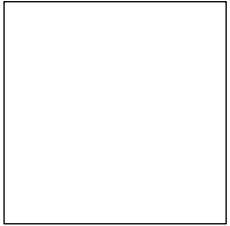
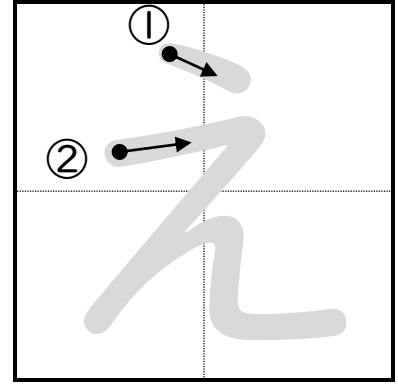
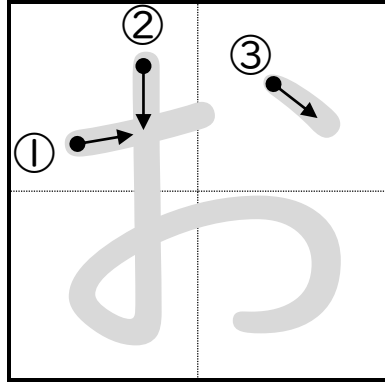
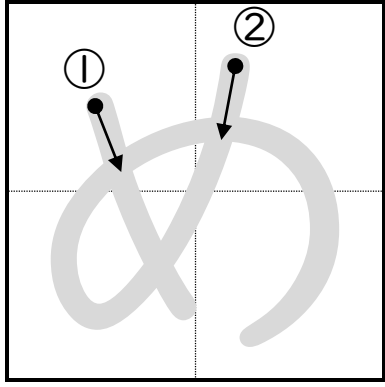
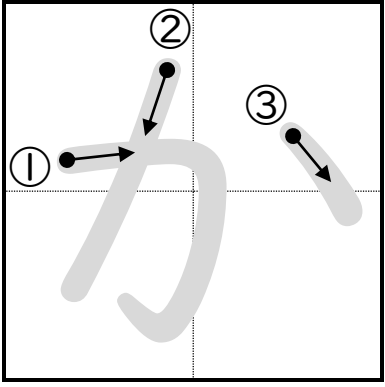

め

がね

おかみ

んぴつ

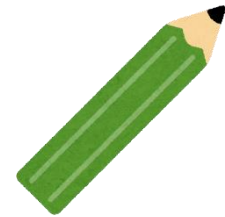
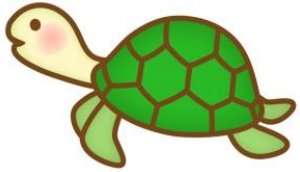

ひらがなを なぞろう

(

がつ)

にち

なまえ)

)

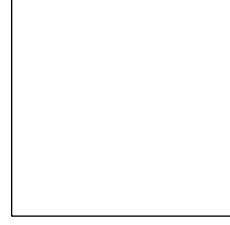
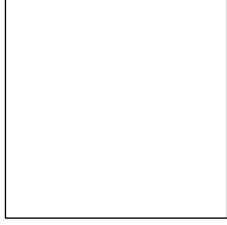
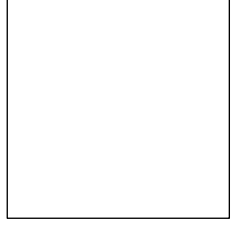
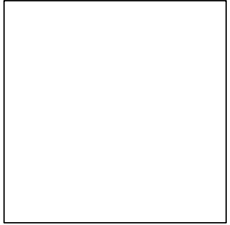
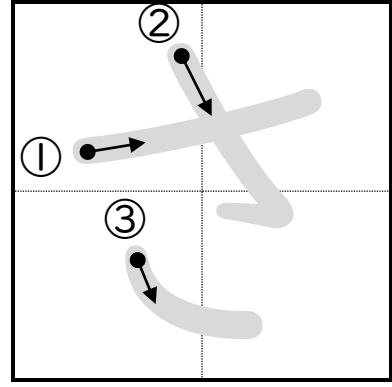
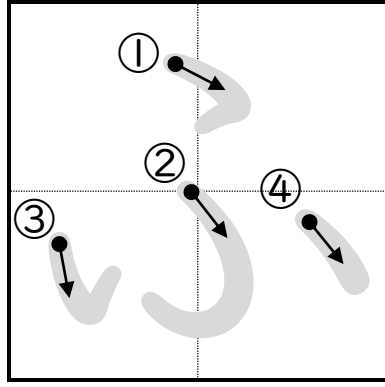
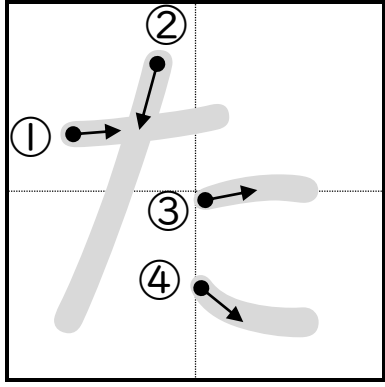
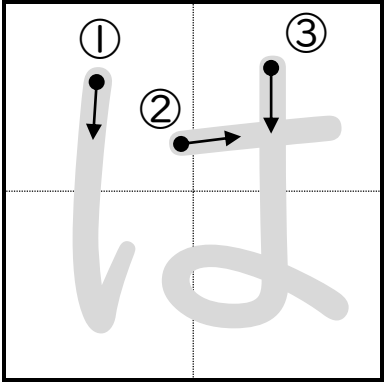

はさみ



たいこ



うせん



かな

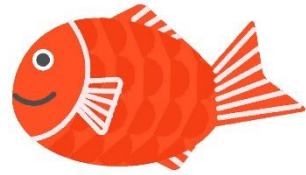

ひらがなを なぞろう

(

がっ)

にち

なまえ)

)

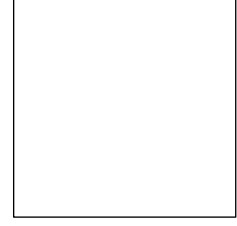
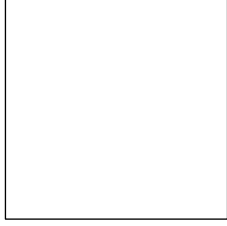
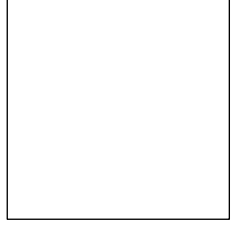
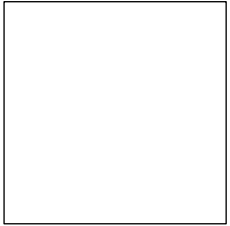
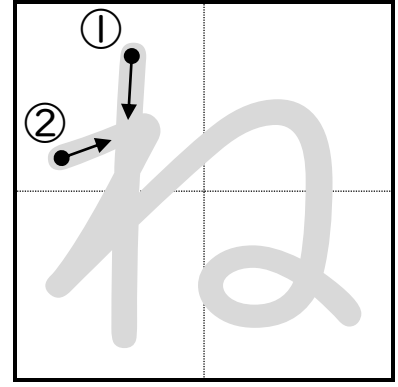
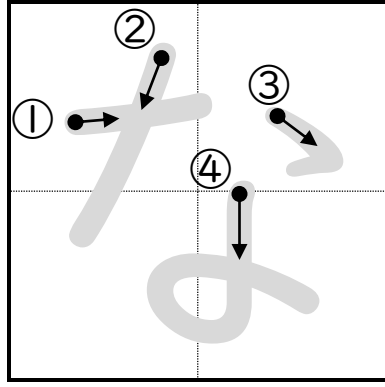
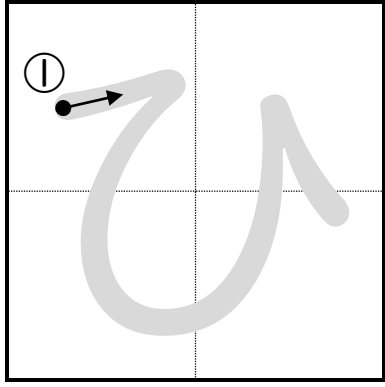
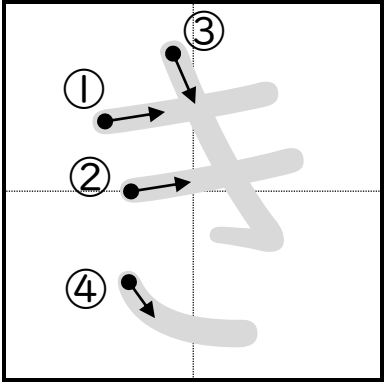

つね

まわり

べ

こ

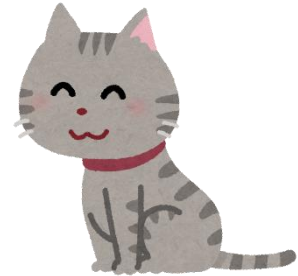

ひらがなを なぞろう

(

がっ)

にち

なまえ)

)

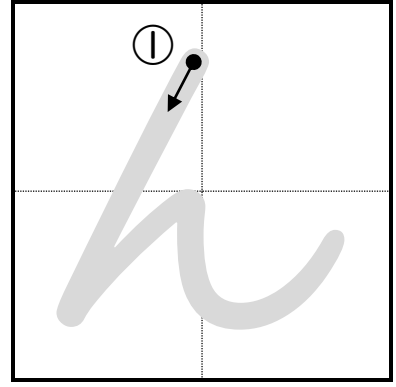
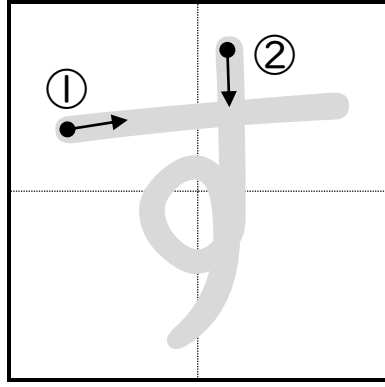
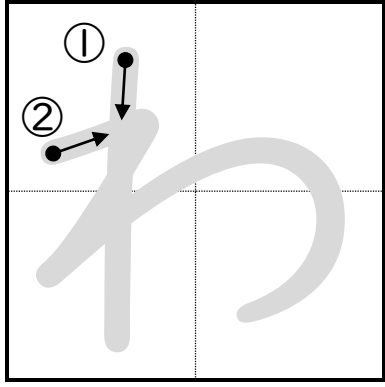
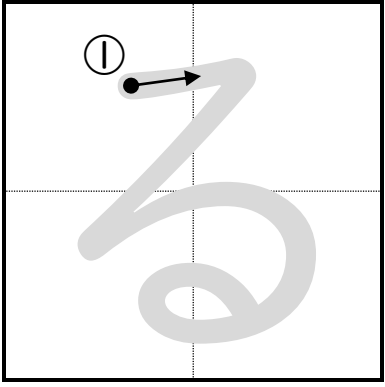

ひらがなを
なぞろう

(

がっ)

にち

なまえ)

)

い

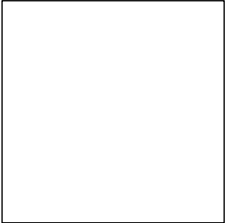

か

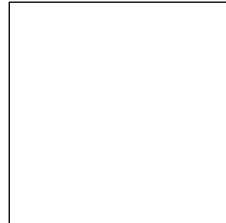
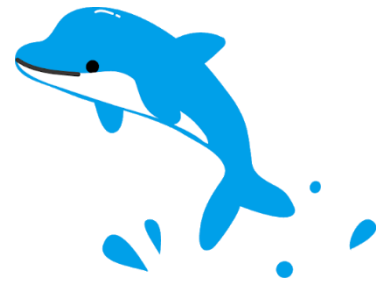

に

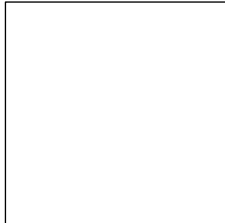

ず
め

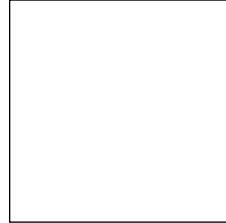

ん
ぶ
ん



