

H(G) 階段 3 階 平面詳細図 1:50

C 階段 1 階 平面詳細図 1:50

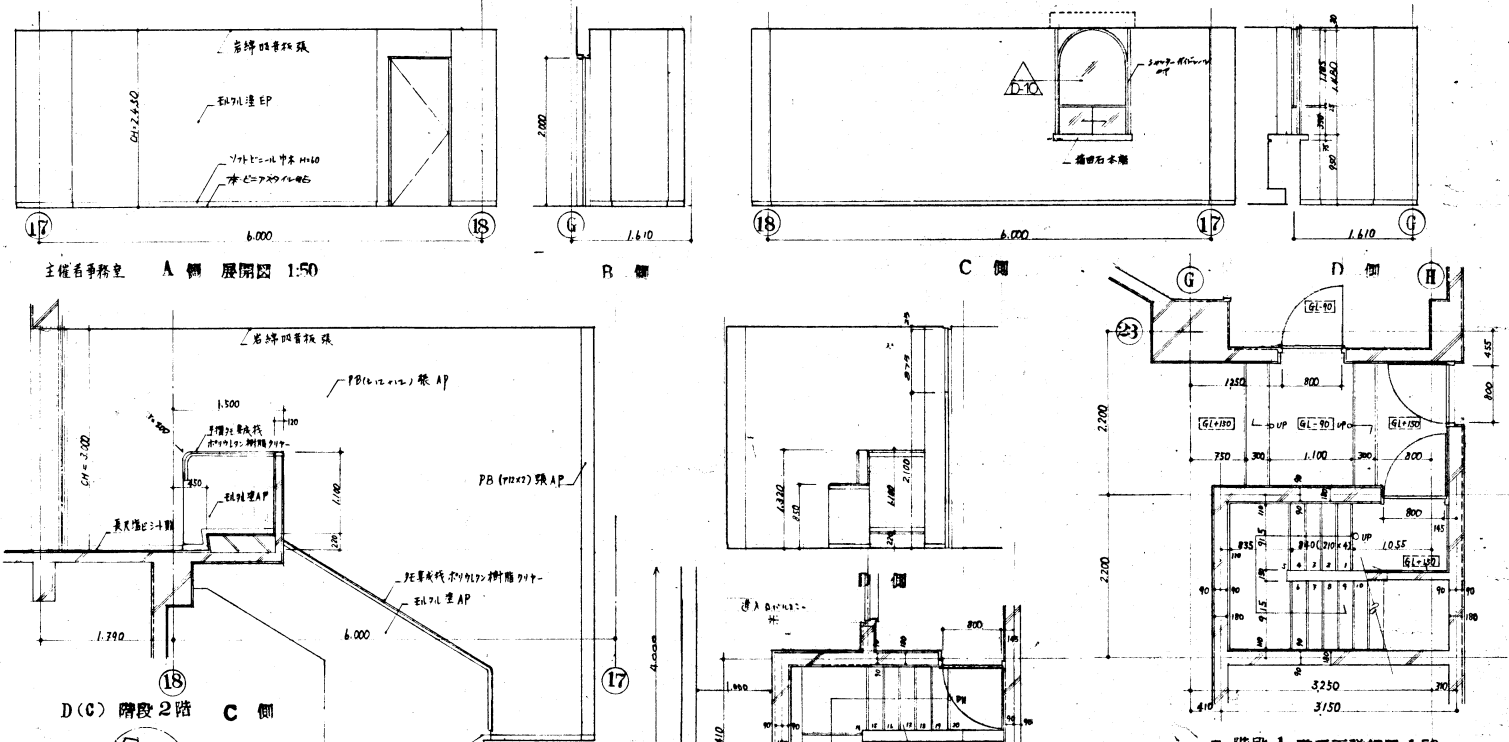

主権事務所 A 欄 展開図 1:50

D (C) 階段 2 階 C 側

F (E) 階段 平面詳細図 1:50

F (E) 階段 2 階 平面詳細図 1:50

F 階段 1 階 平面詳細図 1:50

F (E) 階段 断面詳細図 1:50

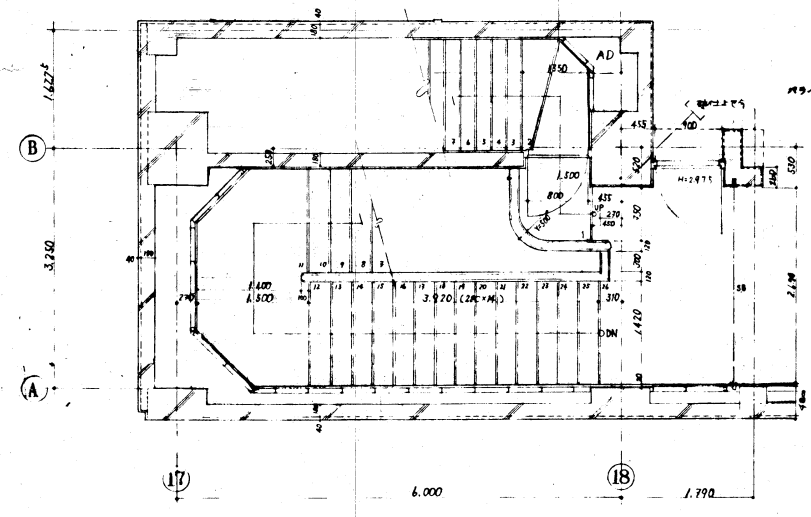

D(C) 階段 2 階 平面詳細図 1:50

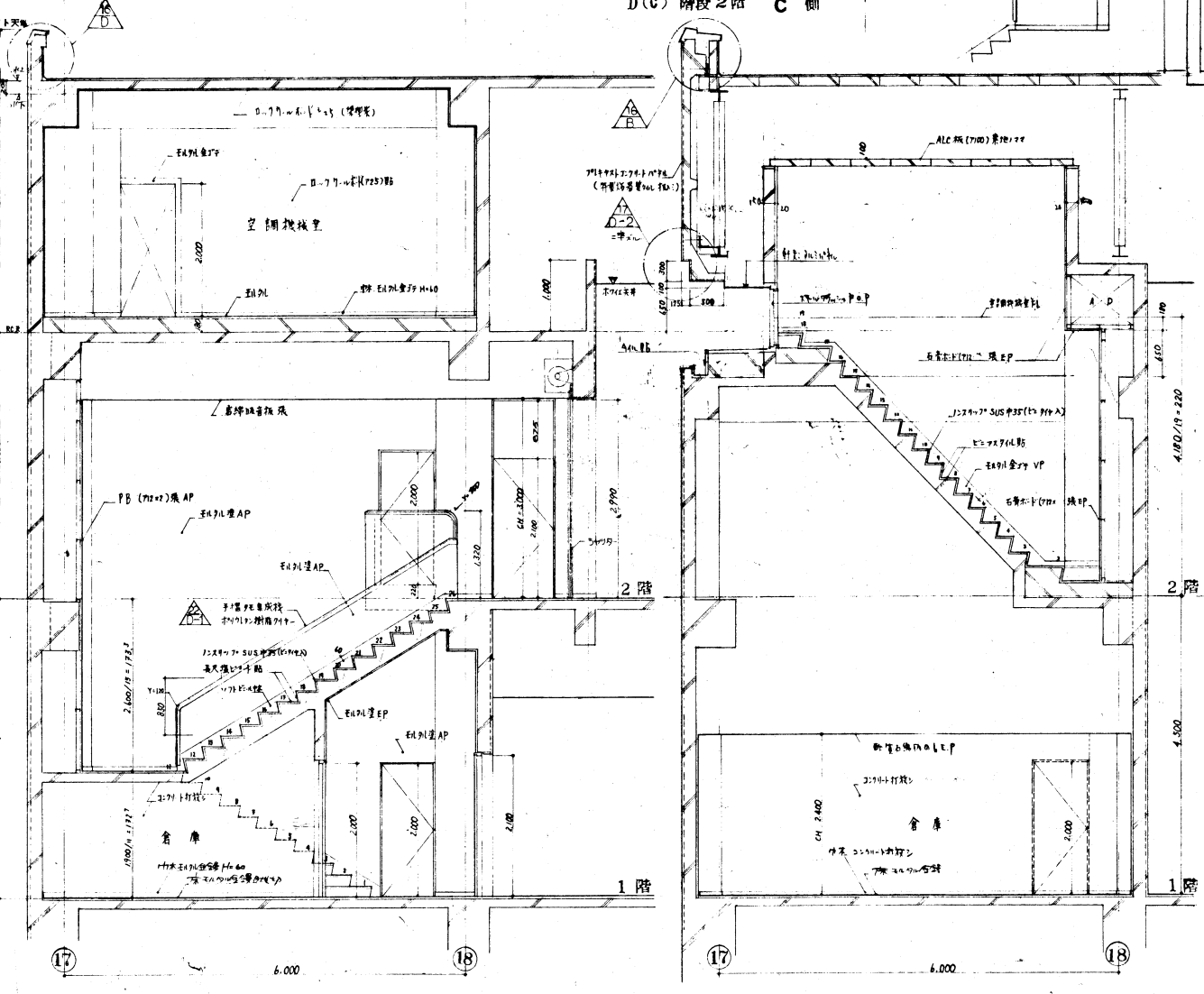

D(C) 階段 断面詳細図 1:50

① 断面

H(G) 階段 断面詳細図 1:50

② 断面

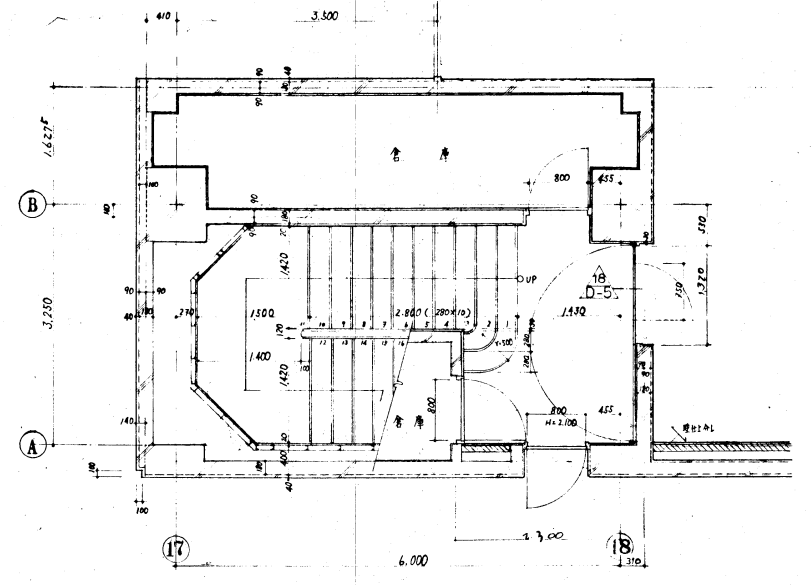

D 階段 1 階 平面詳細図 1:50

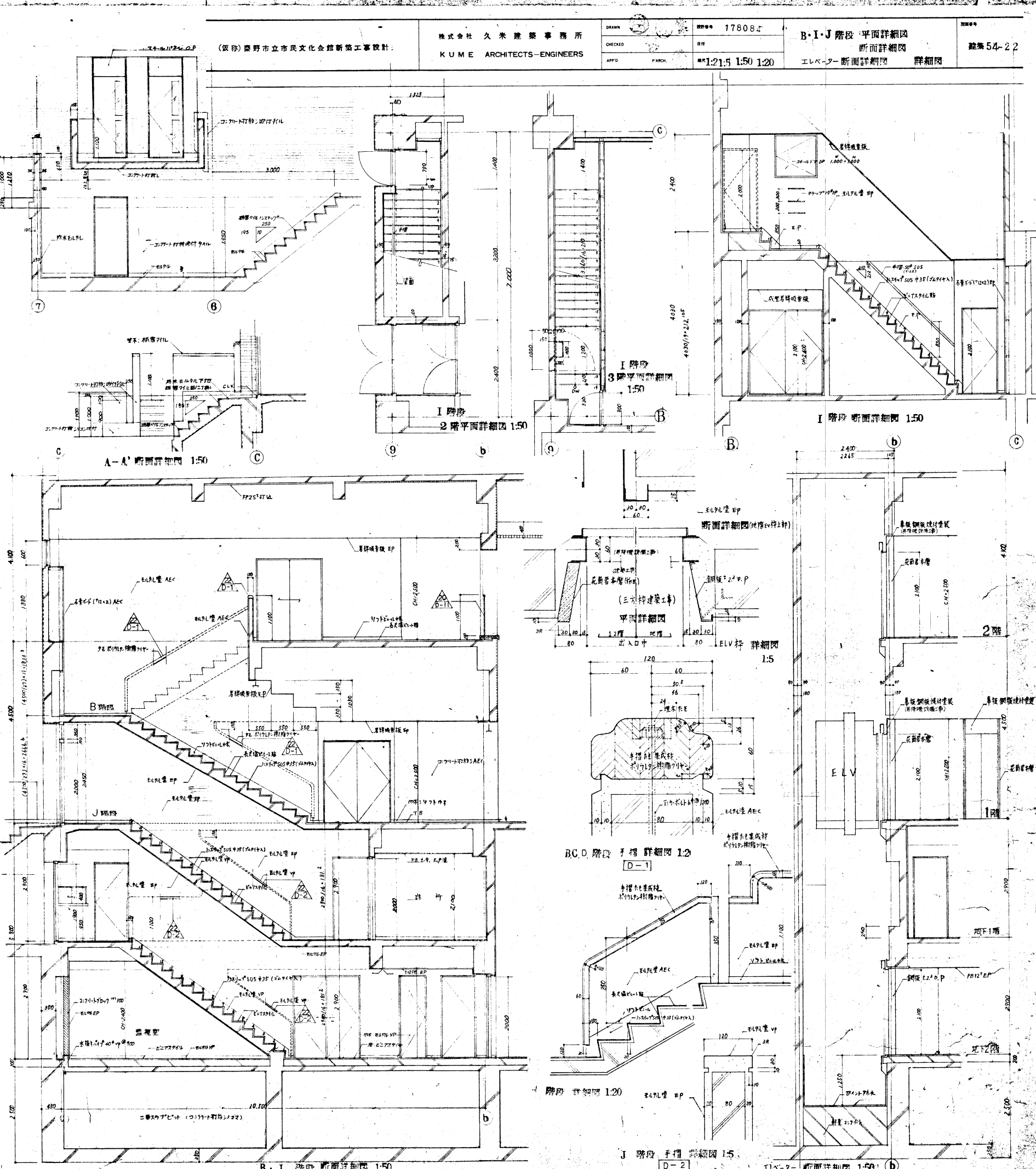
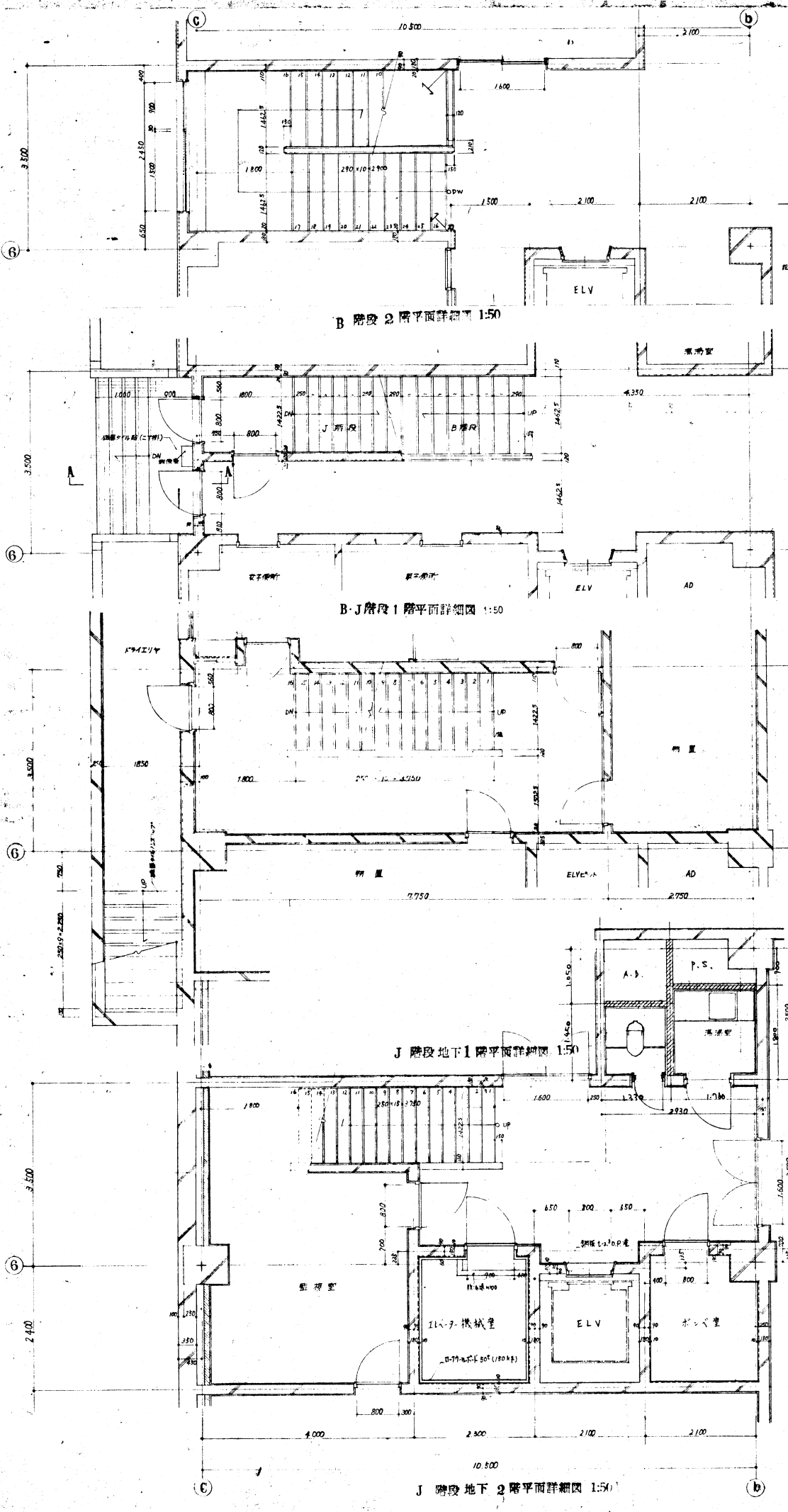



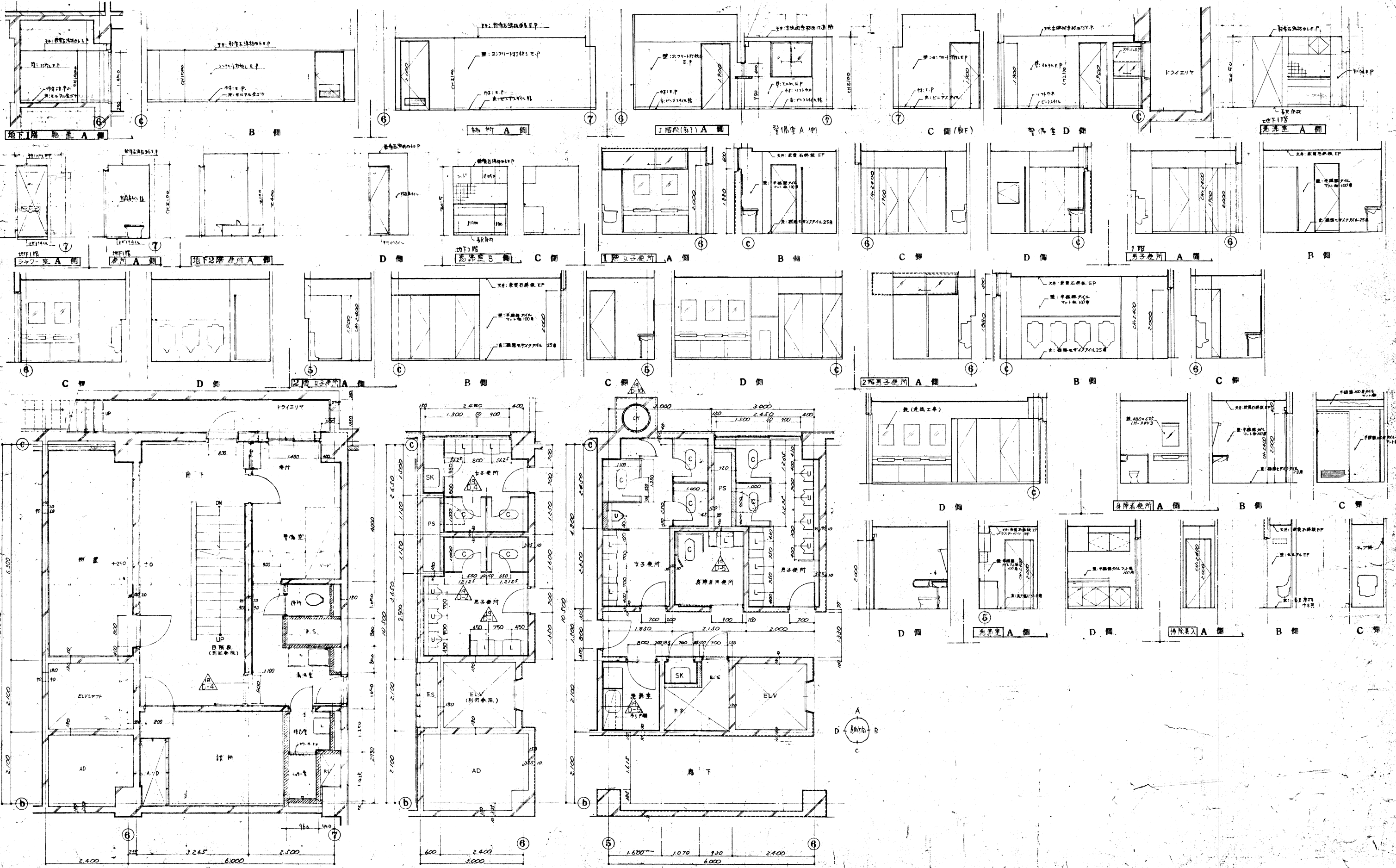

地下1階 男用トイレ 廻り平面詳細図 1:50

地下2階 女用トイレ 廻り平面詳細図 1:50

1階 身着室用更衣室 廻り平面詳細図 1:50



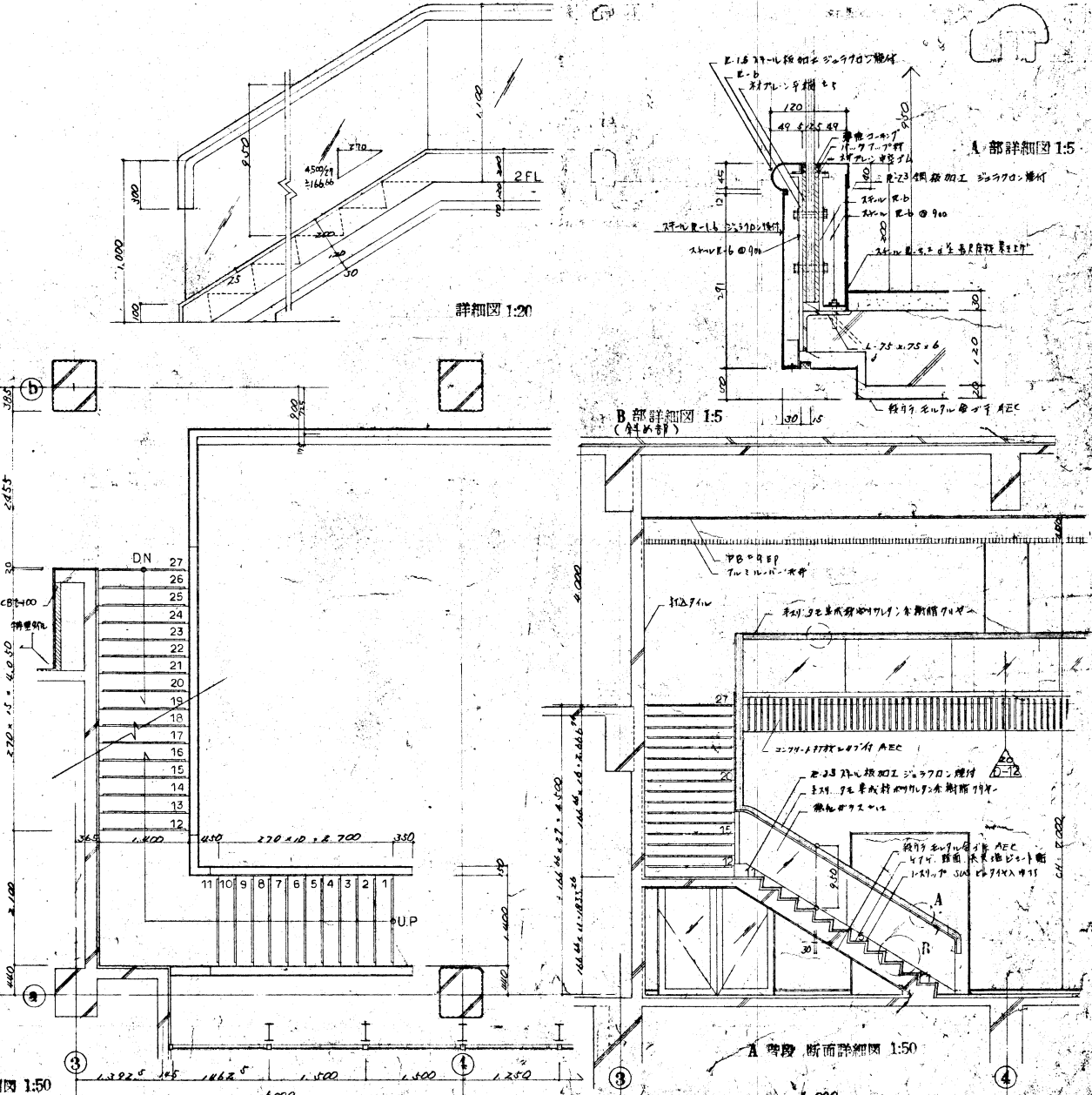
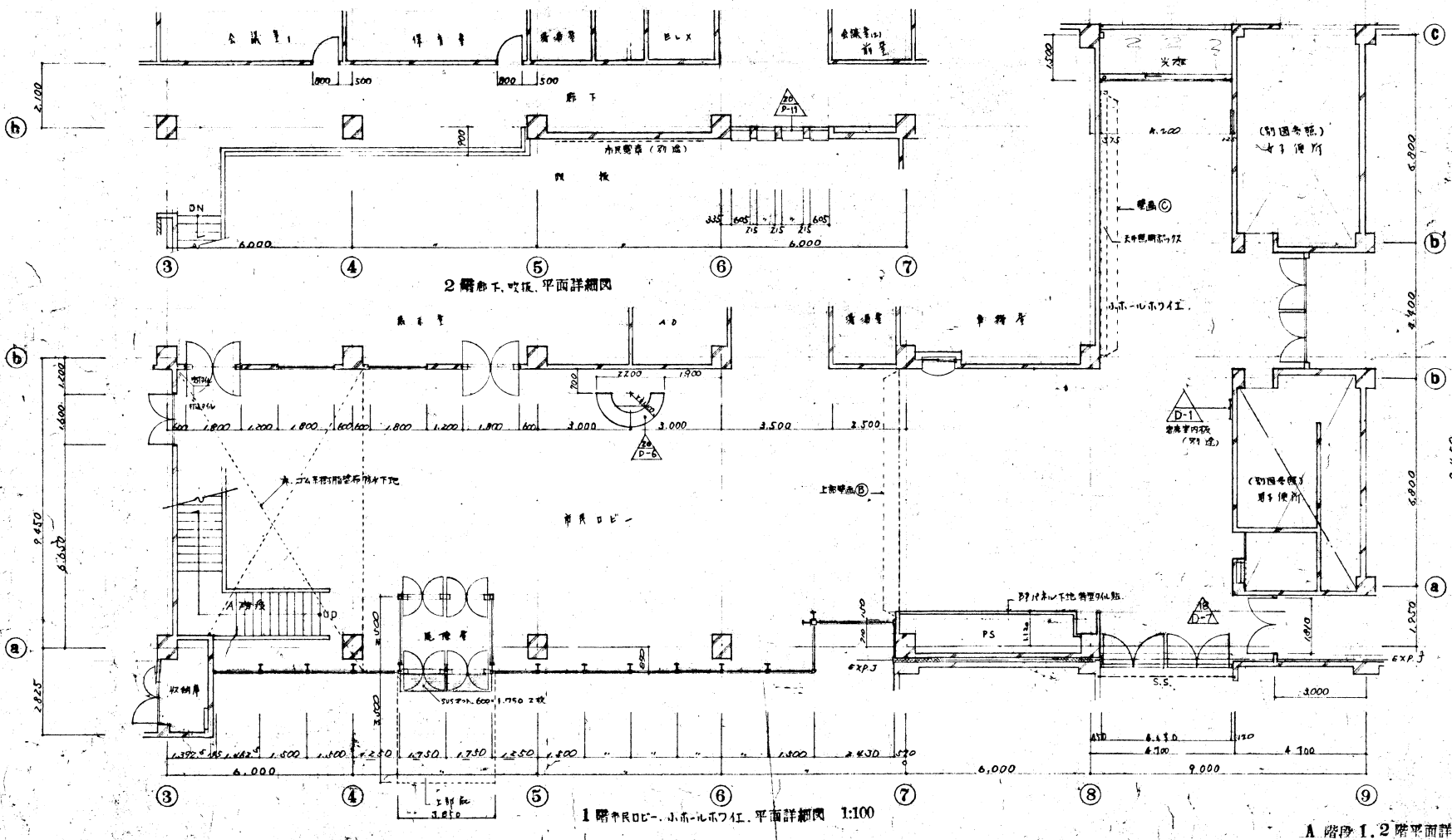
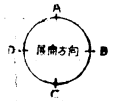
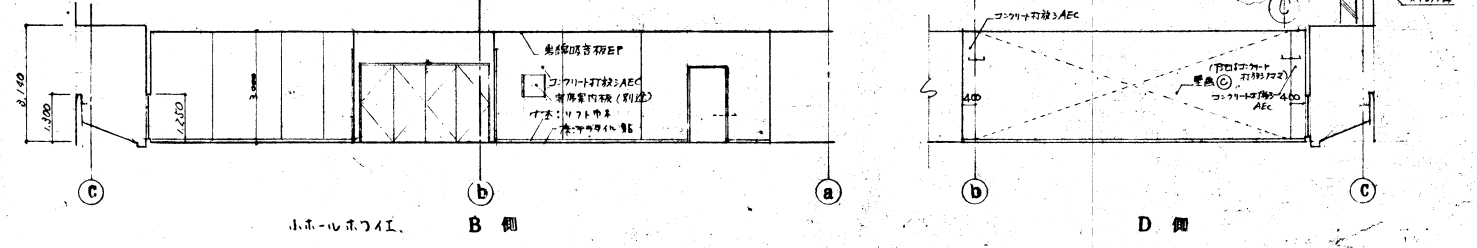
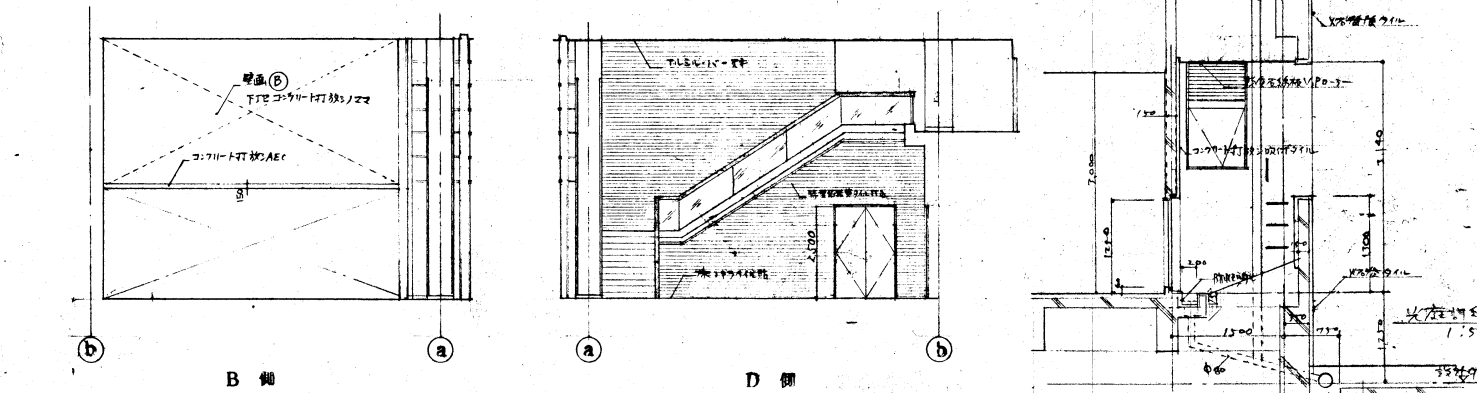
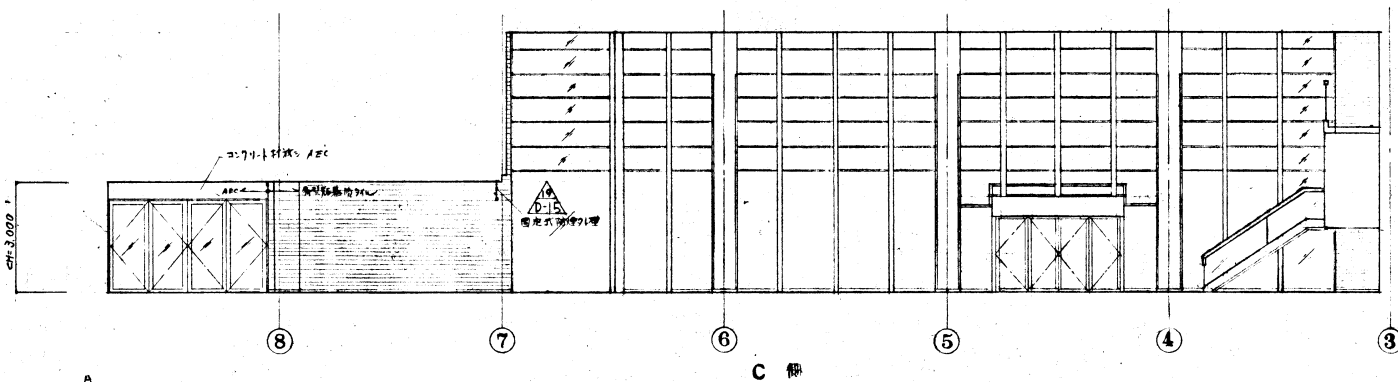
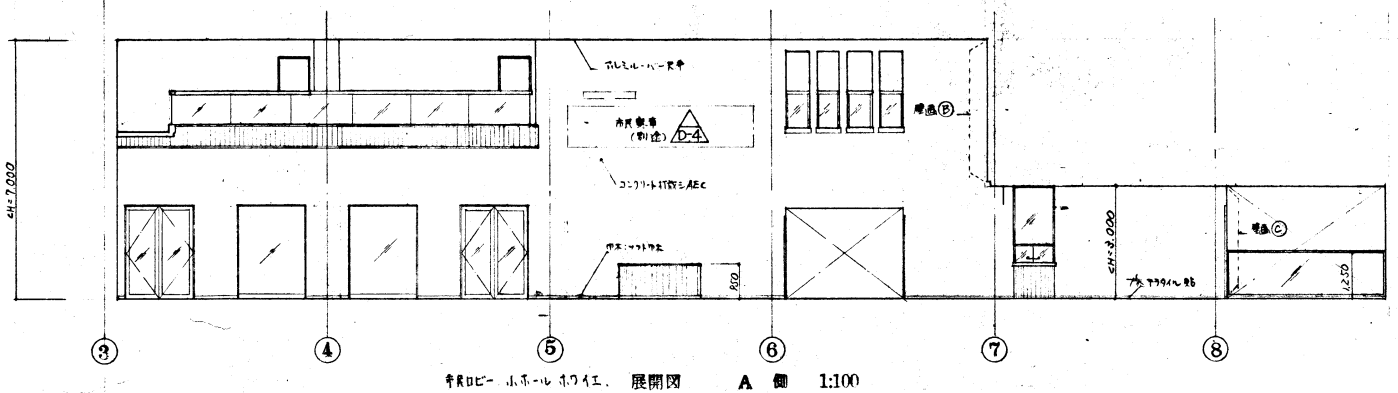

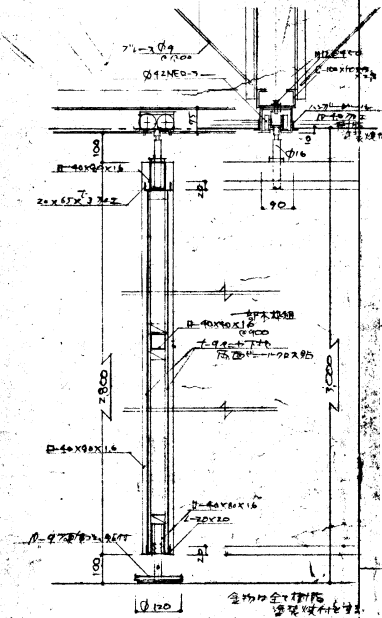
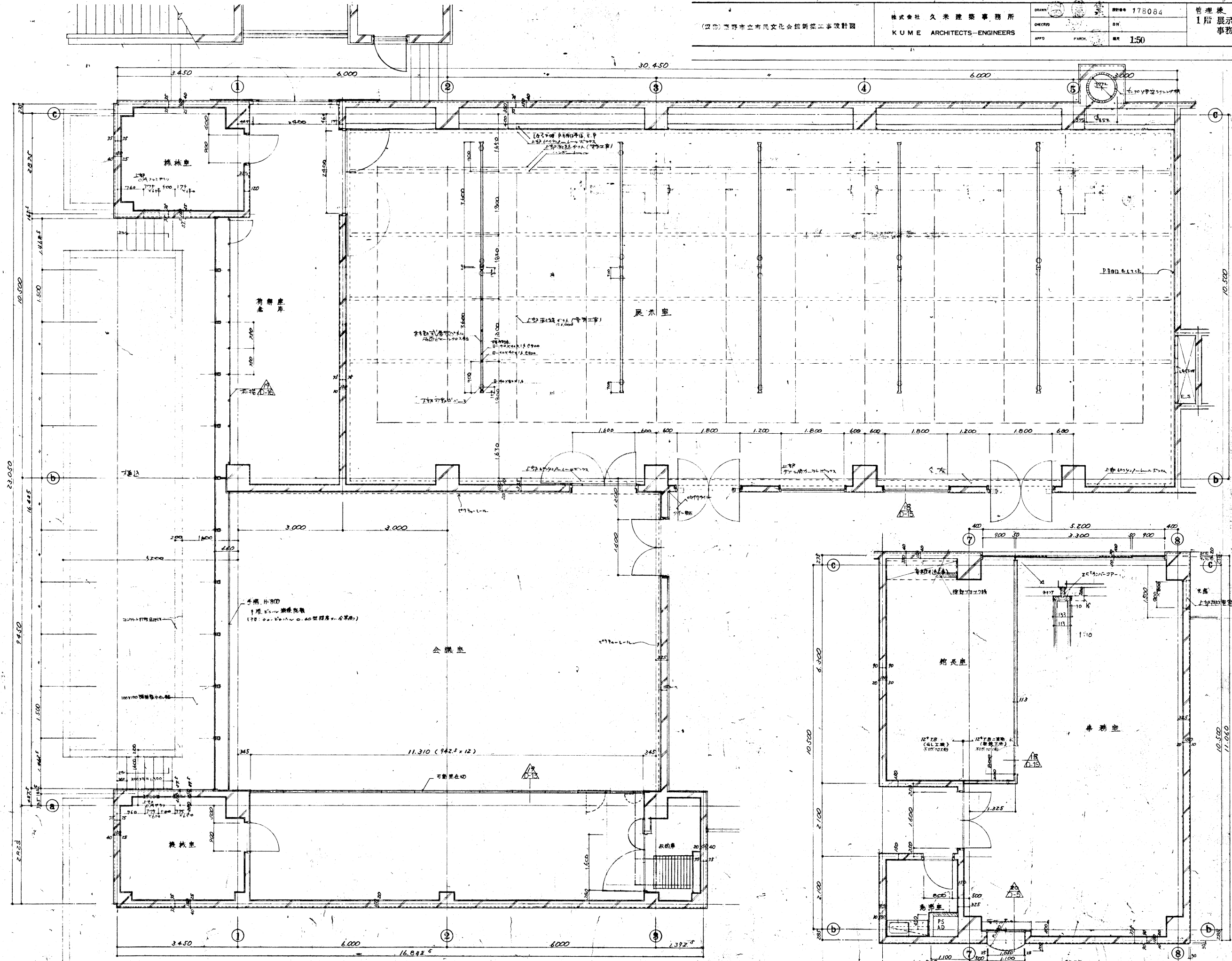

1階 展示室・会議室廻り平面詳細図 1:50

1階 事務室廻り平面詳細図 1:50



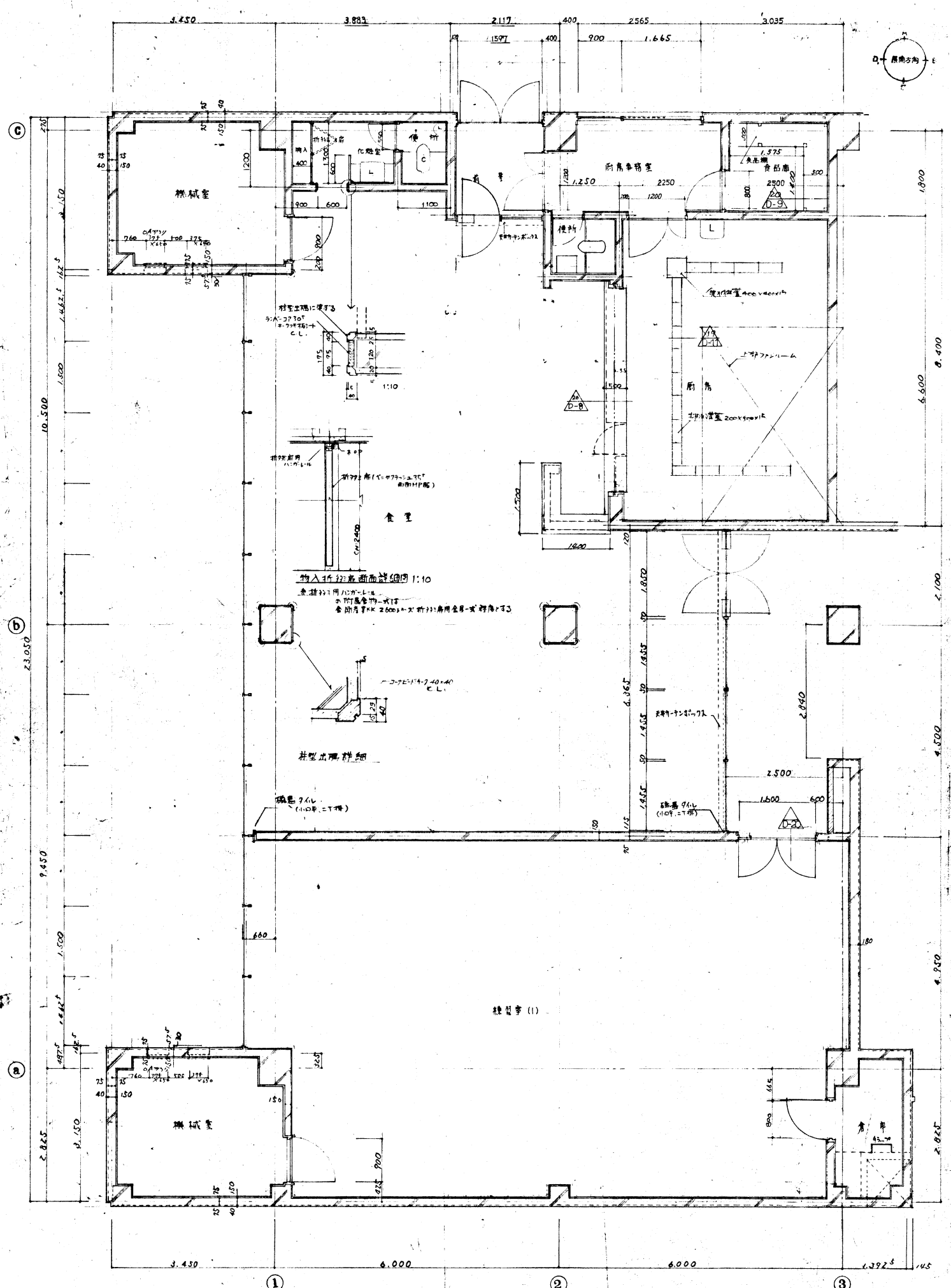

食堂 練成室 (1) 2階平面詳細図 1:50

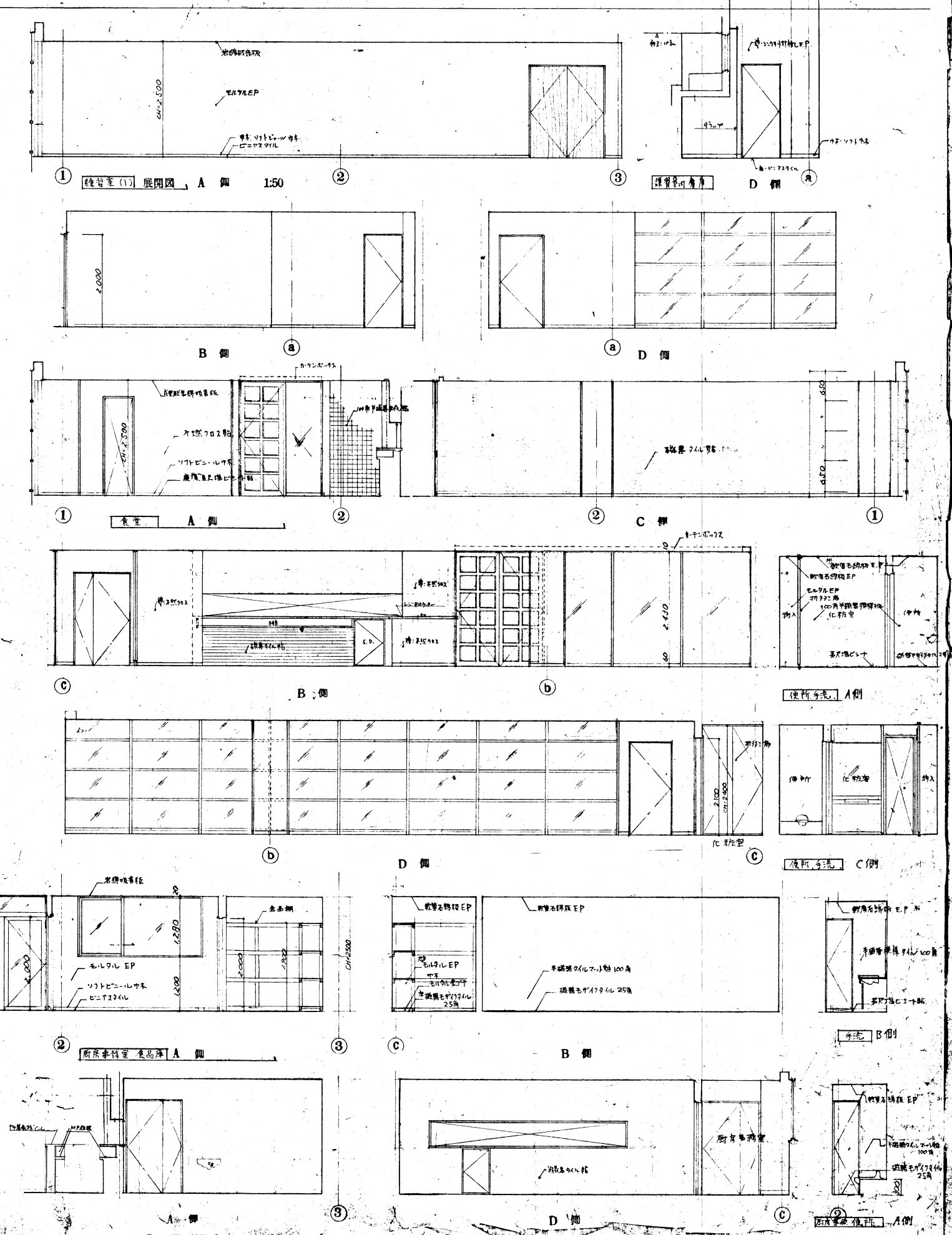

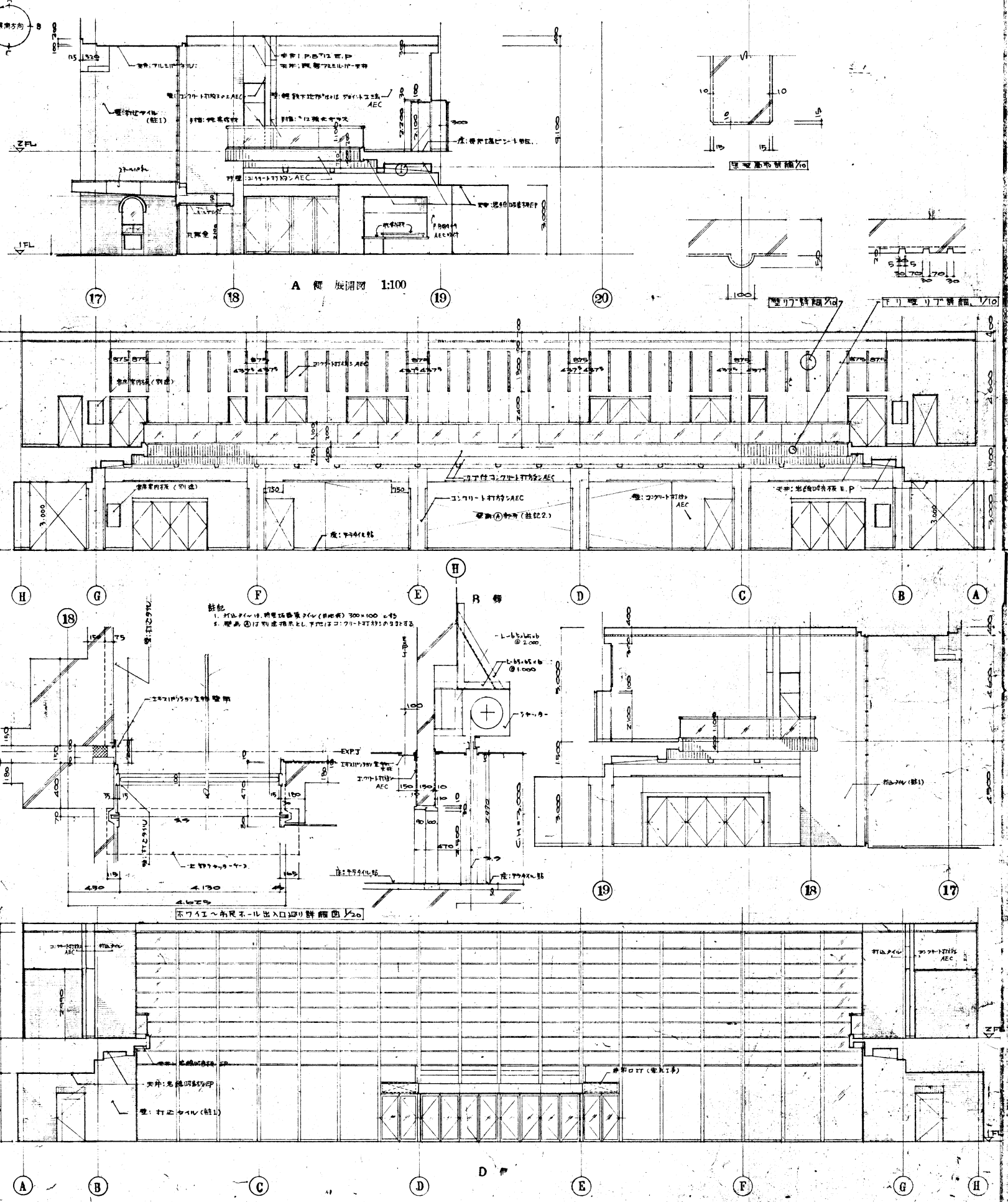
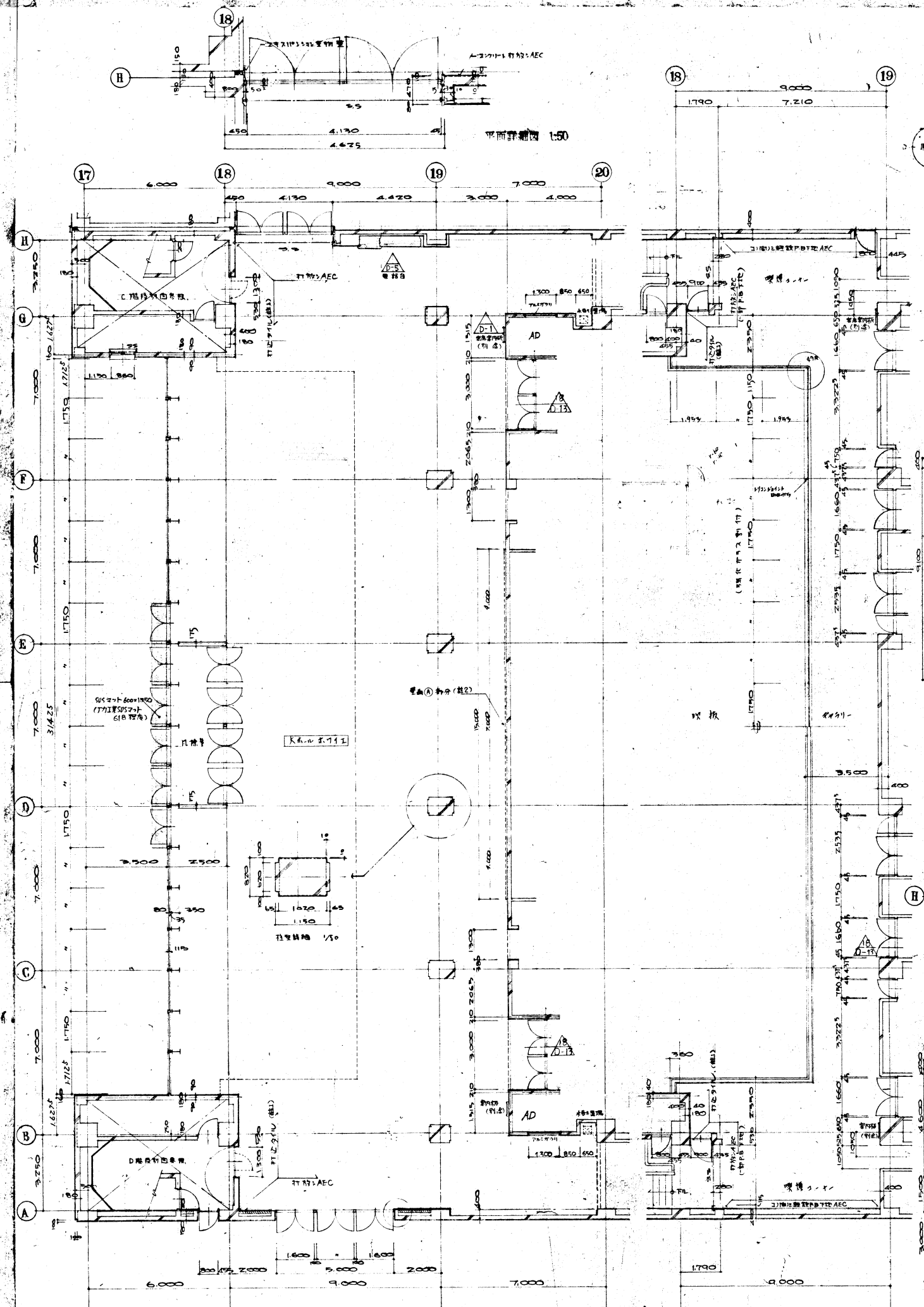

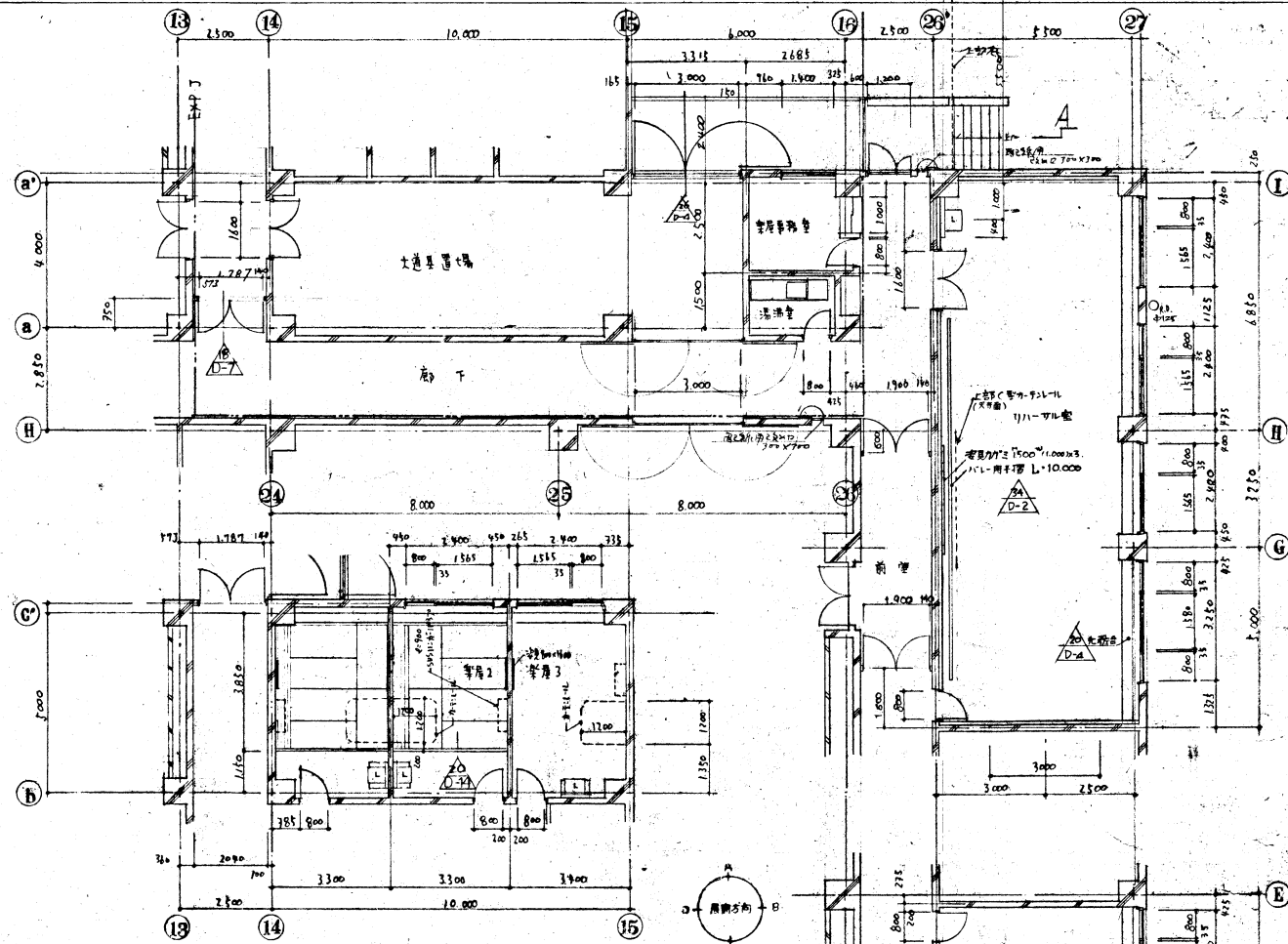
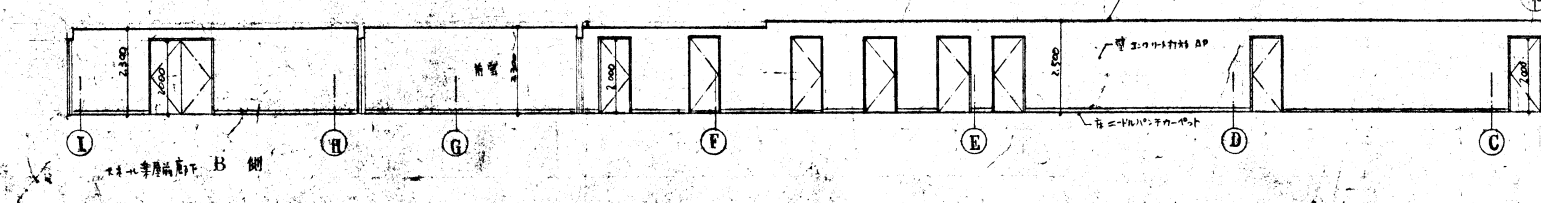
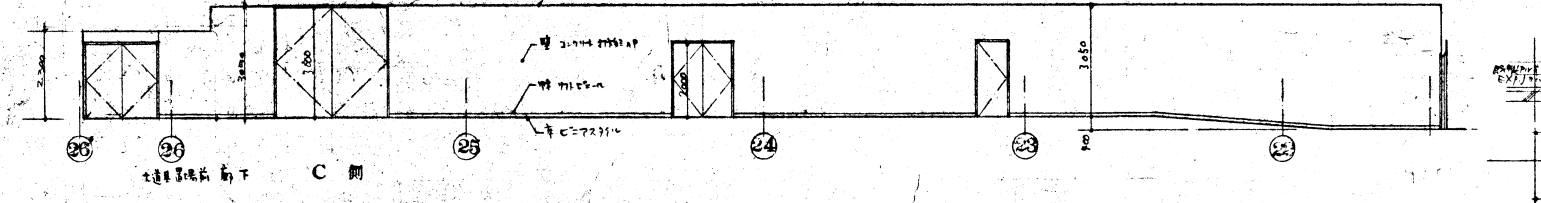
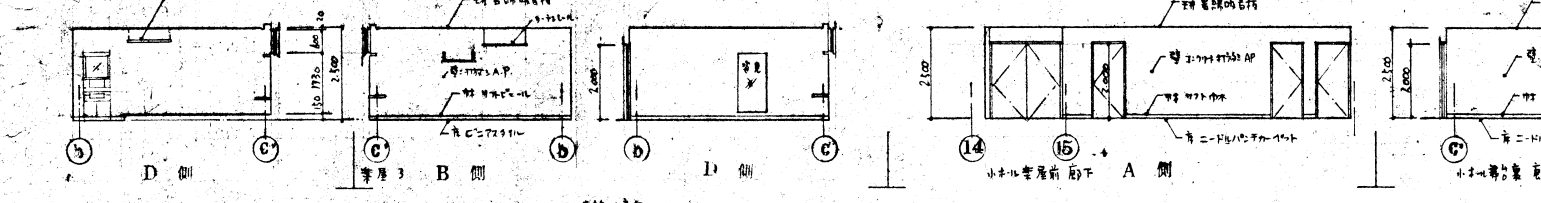
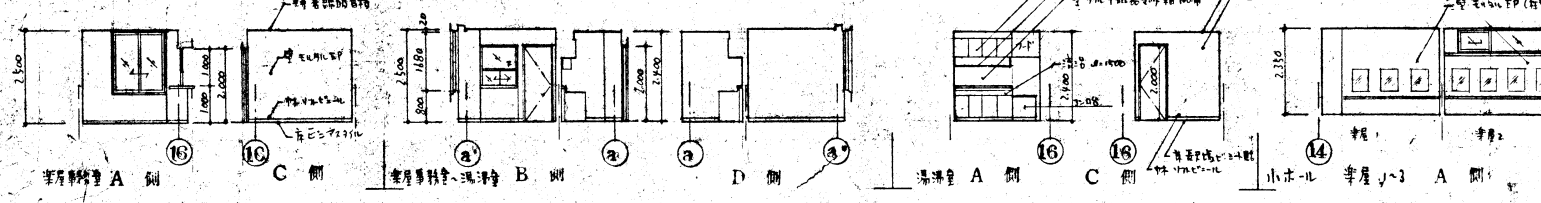
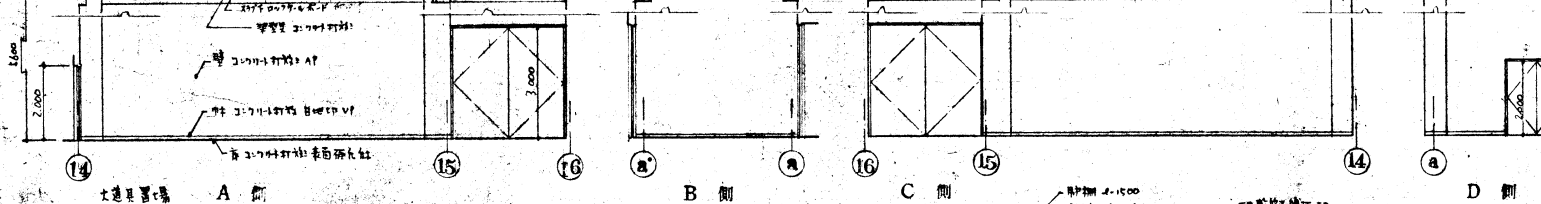
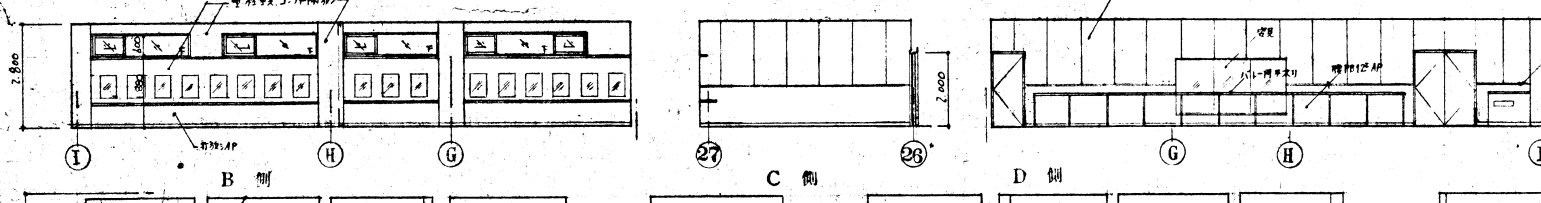
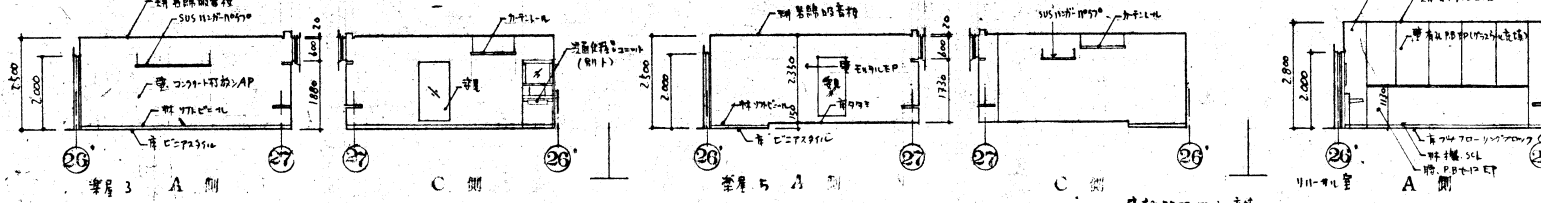
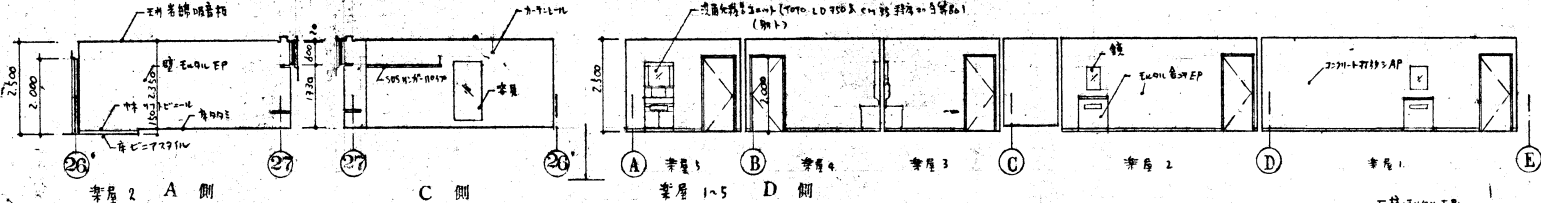
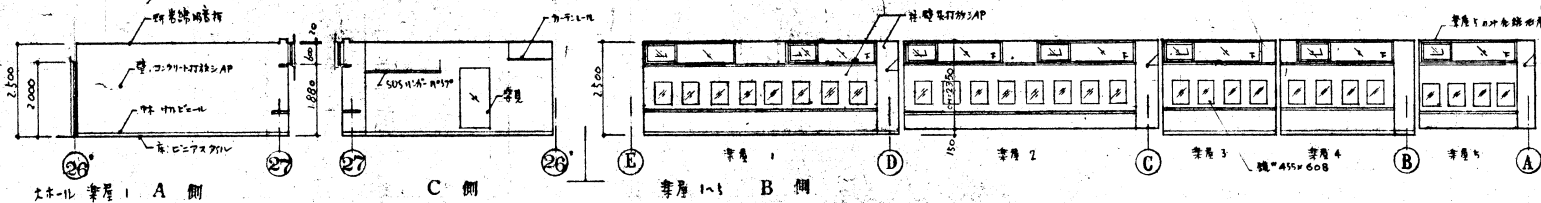

大ホール 平面詳細図 1:100

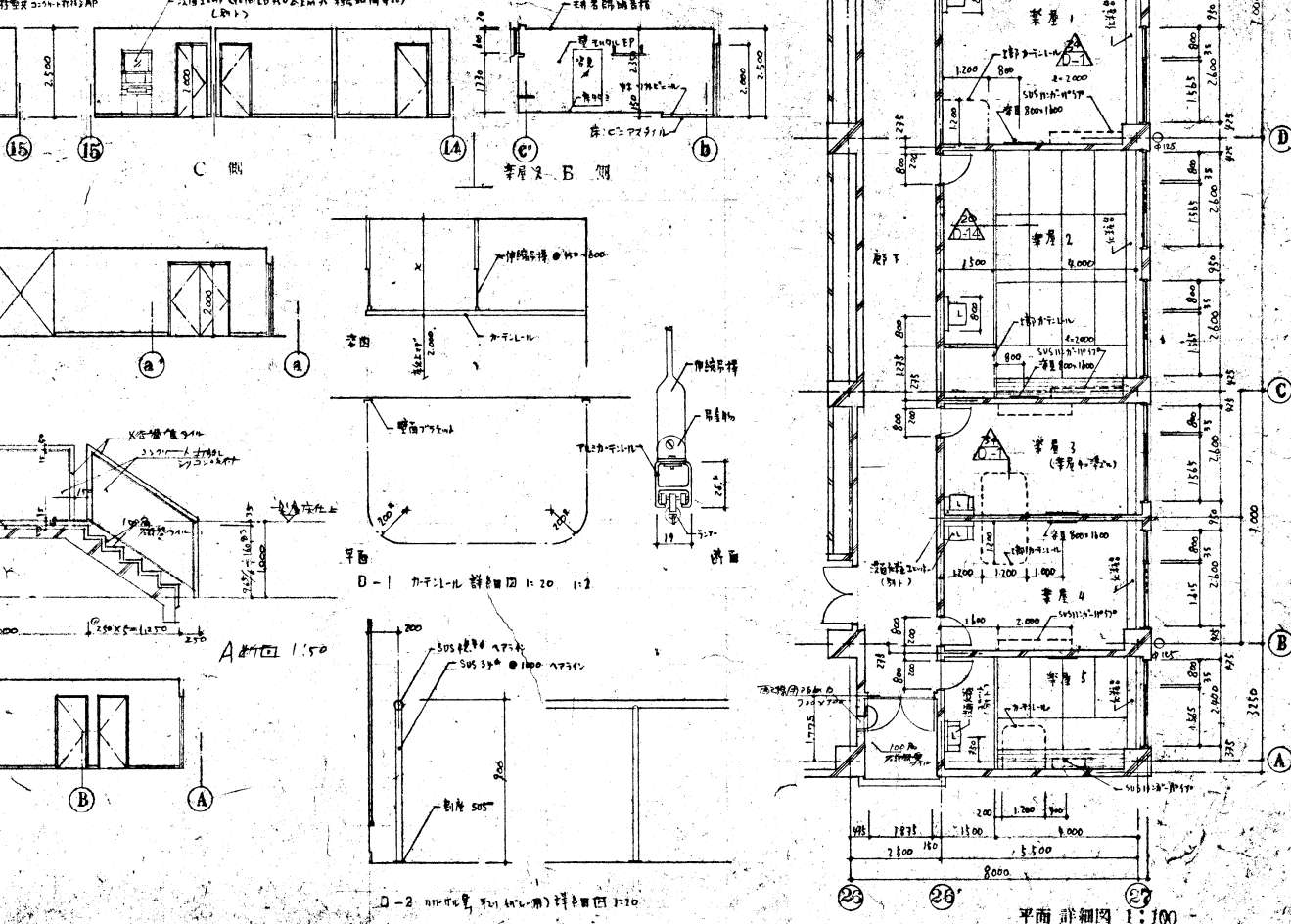

平面詳細図 1:100

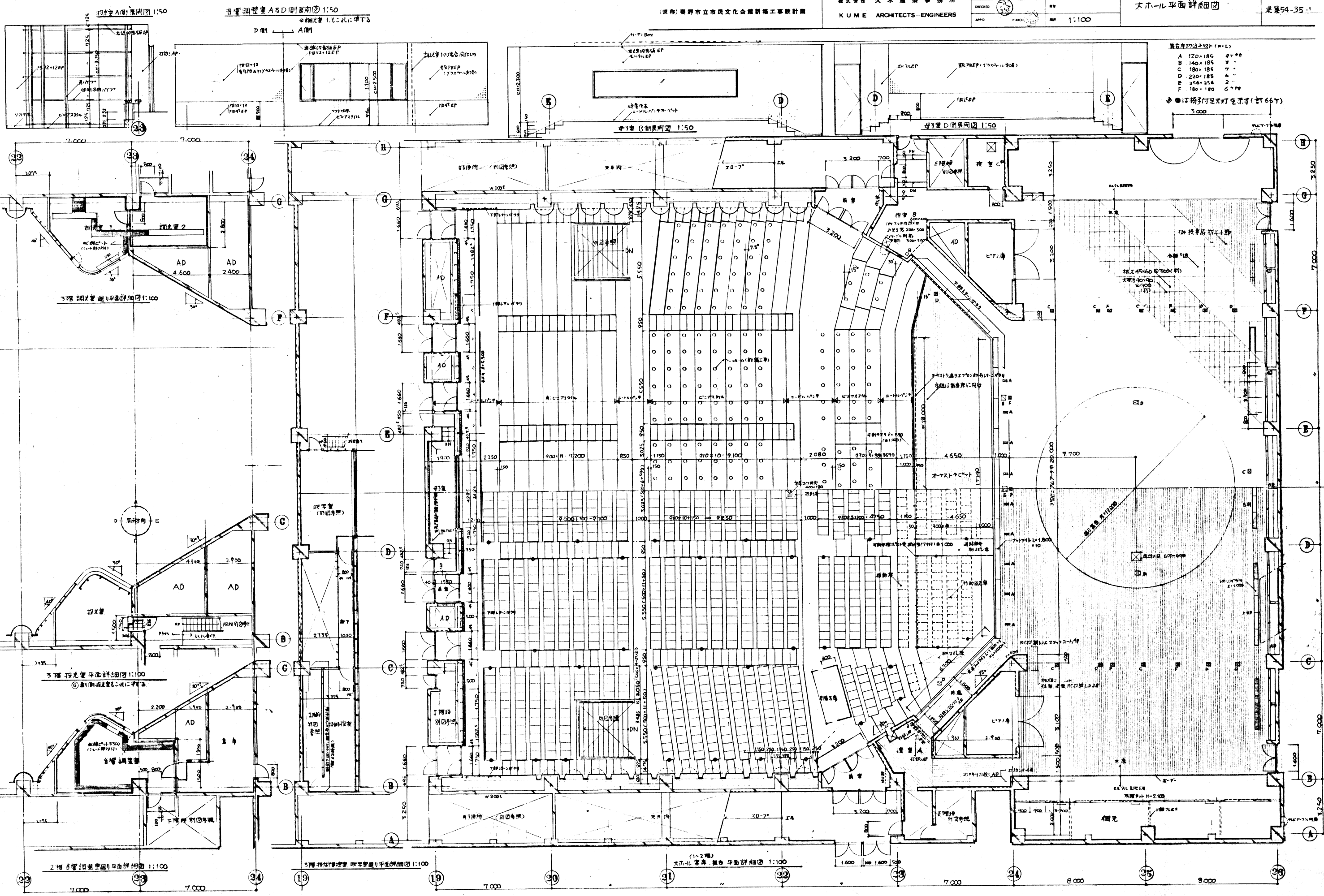

- 観客席寸法22x22 (W×L)
- A 120×185 9ヶ所
  - B 140×185 7ヶ所
  - C 180×185 7ヶ所
  - D 220×185 6ヶ所
  - E 260×254 2ヶ所
  - F 180×180 5ヶ所
- ※ 1ヶ所付足天灯を予定 (計6ヶ所)

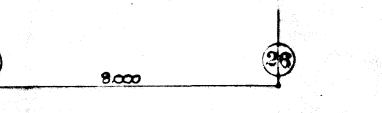
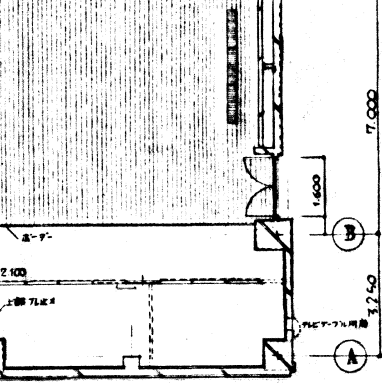
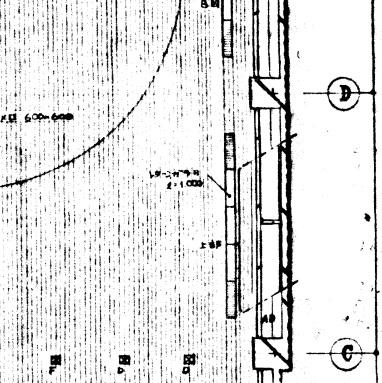
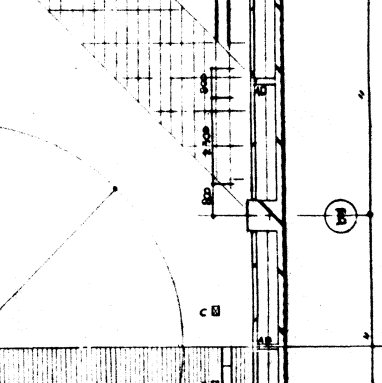
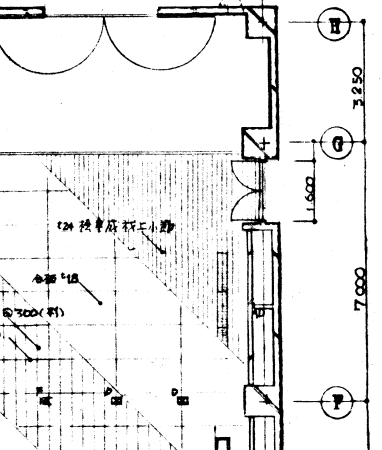
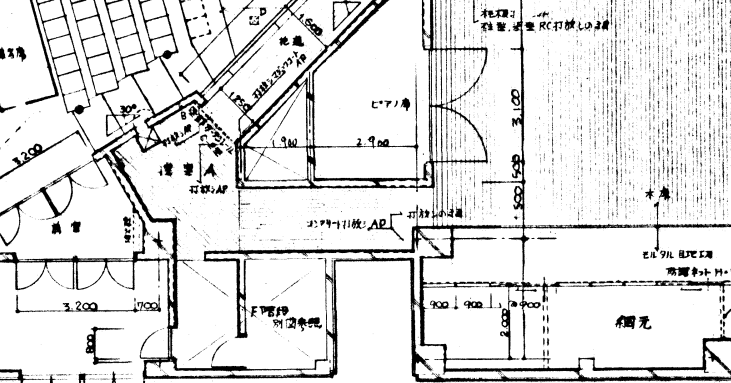
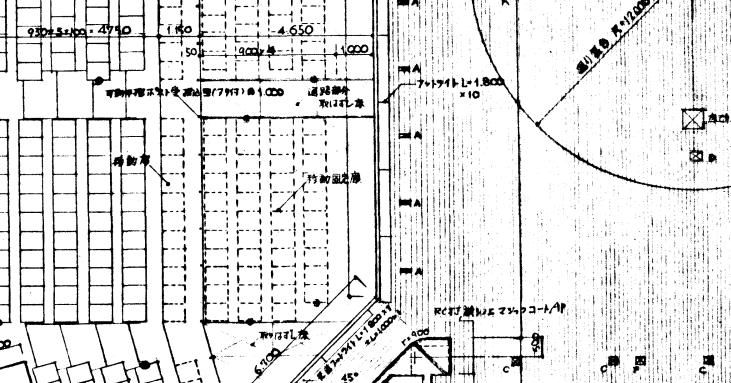
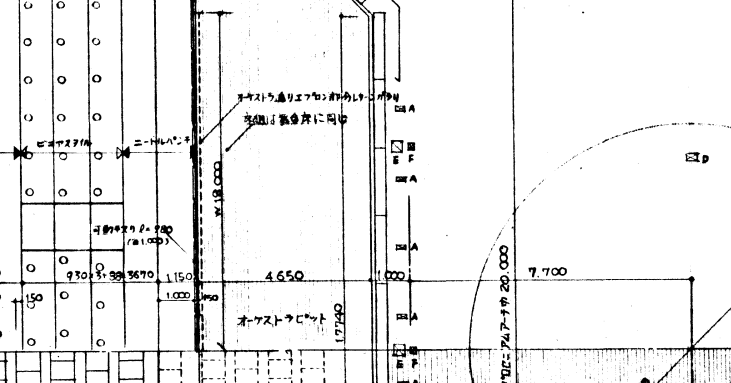
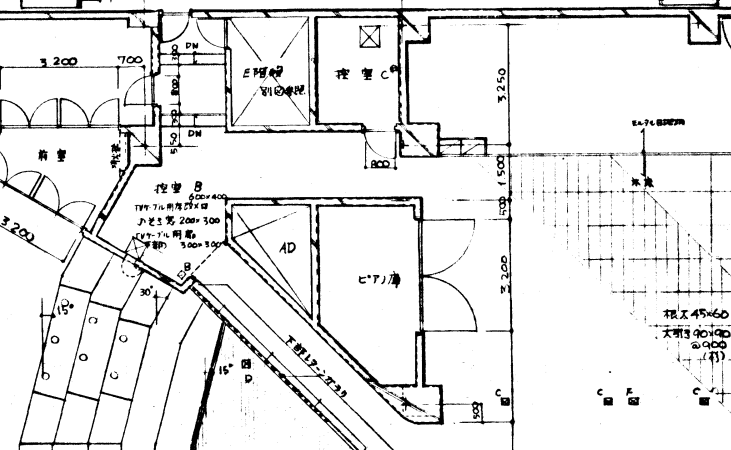
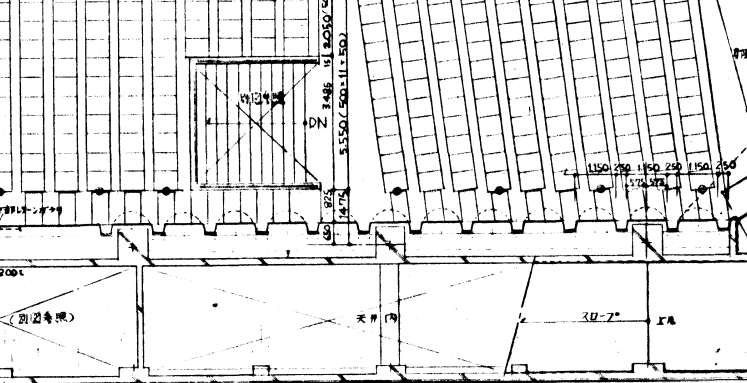
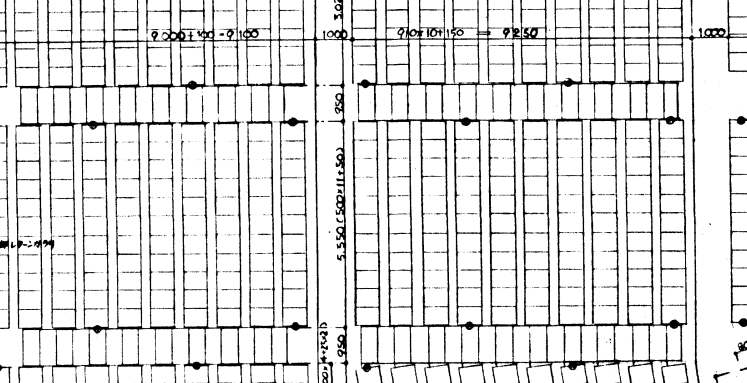
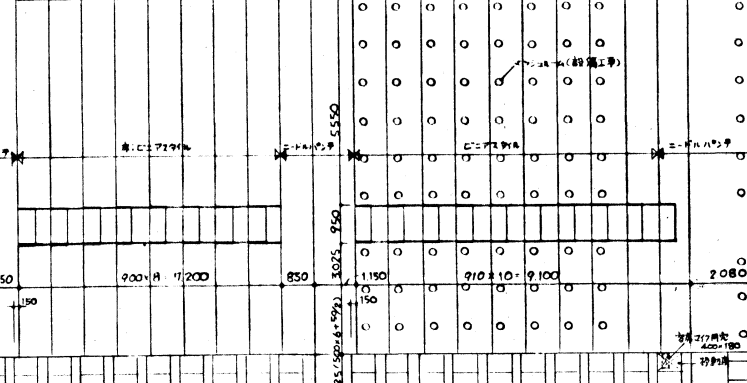
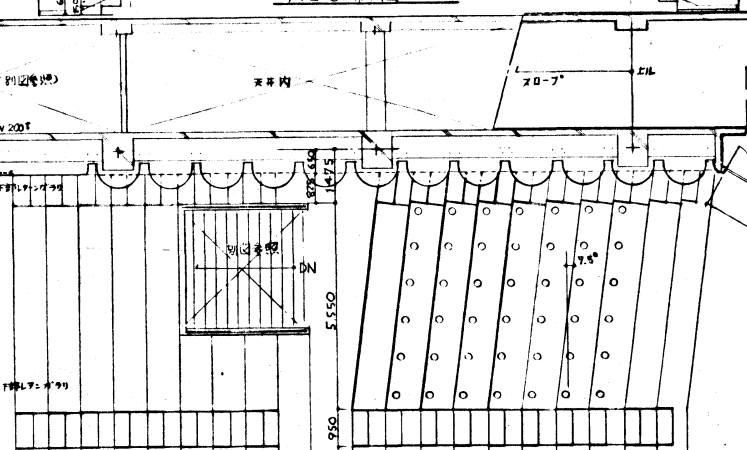
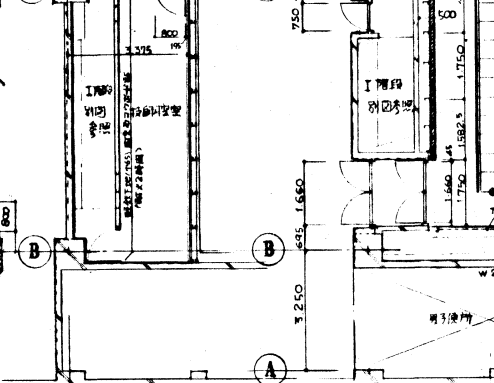
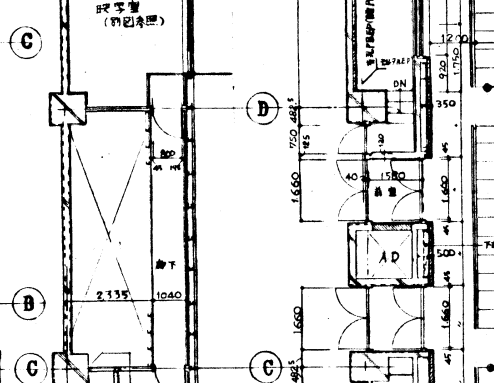
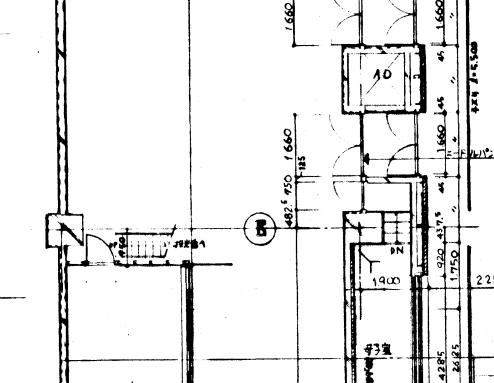
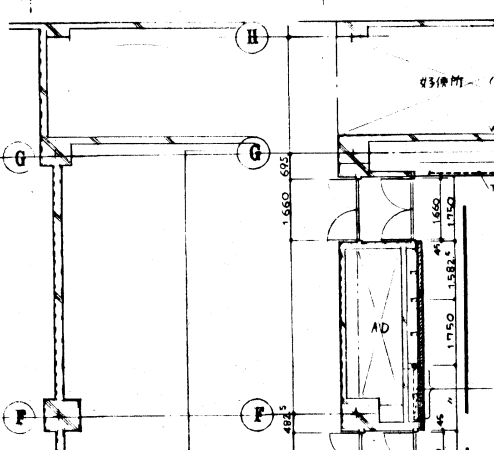
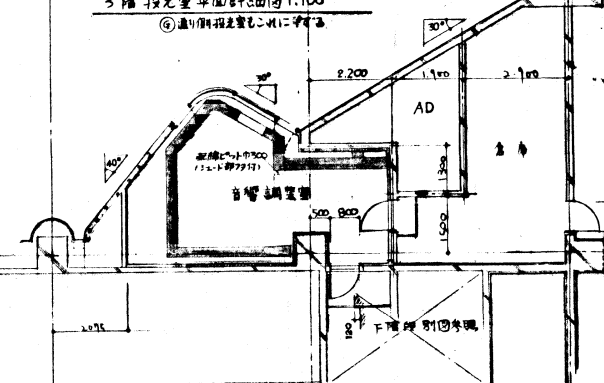
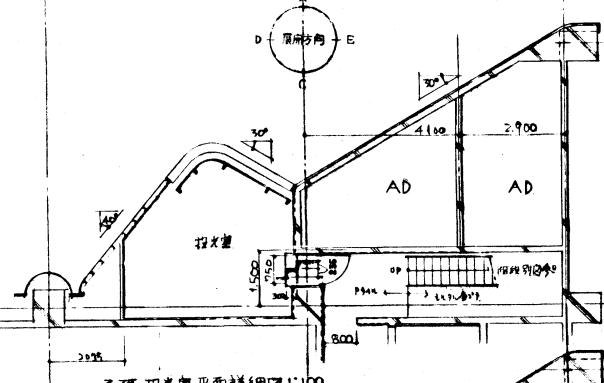
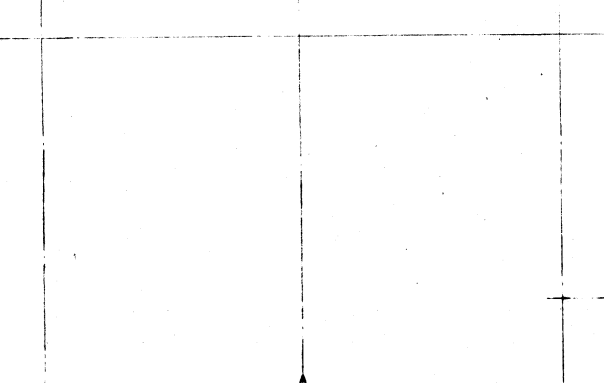
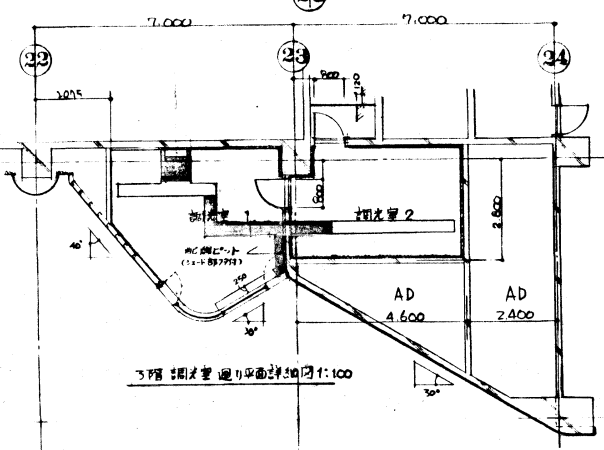
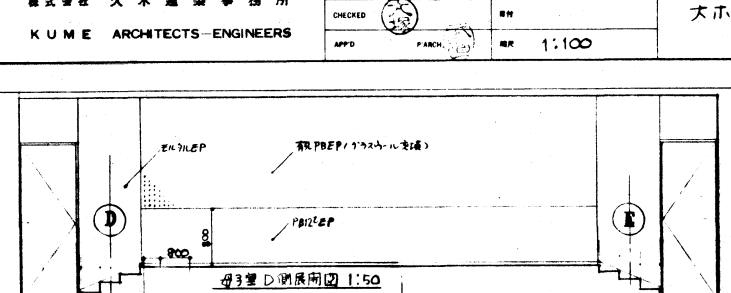
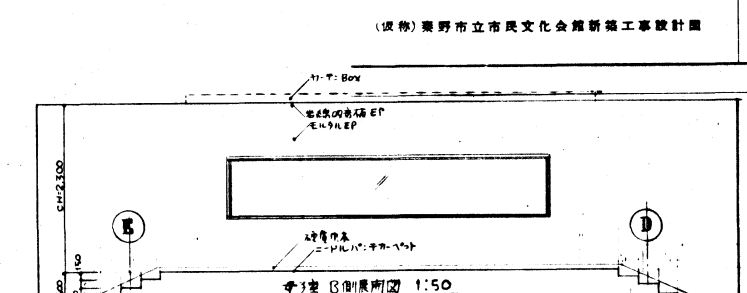
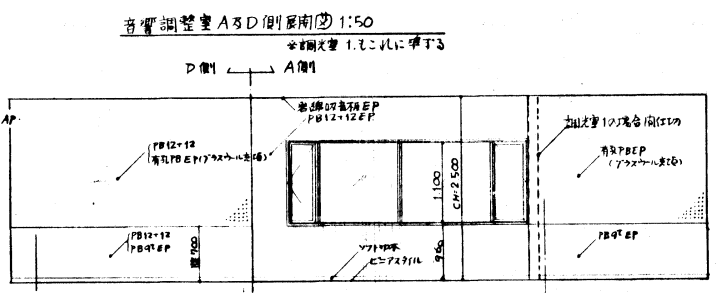
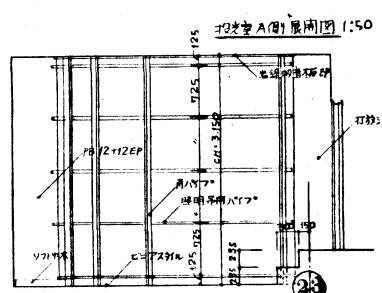

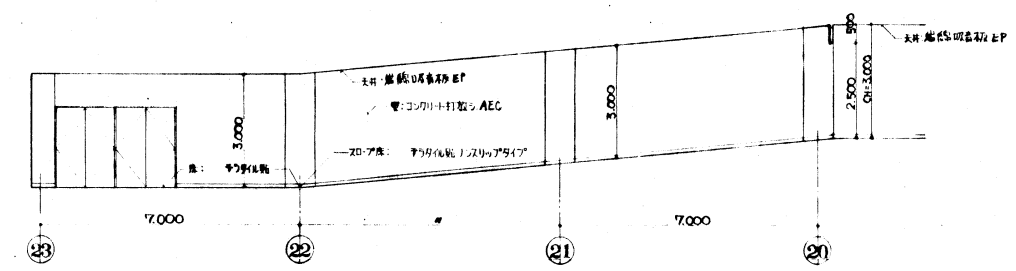

大ホール横断面展開図 1:100

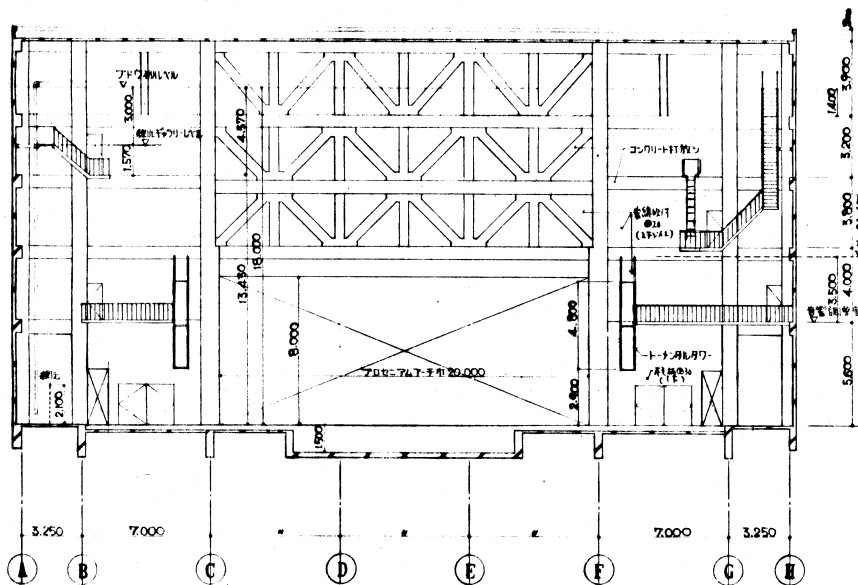

大ホール②4 通り軸組図 1:200

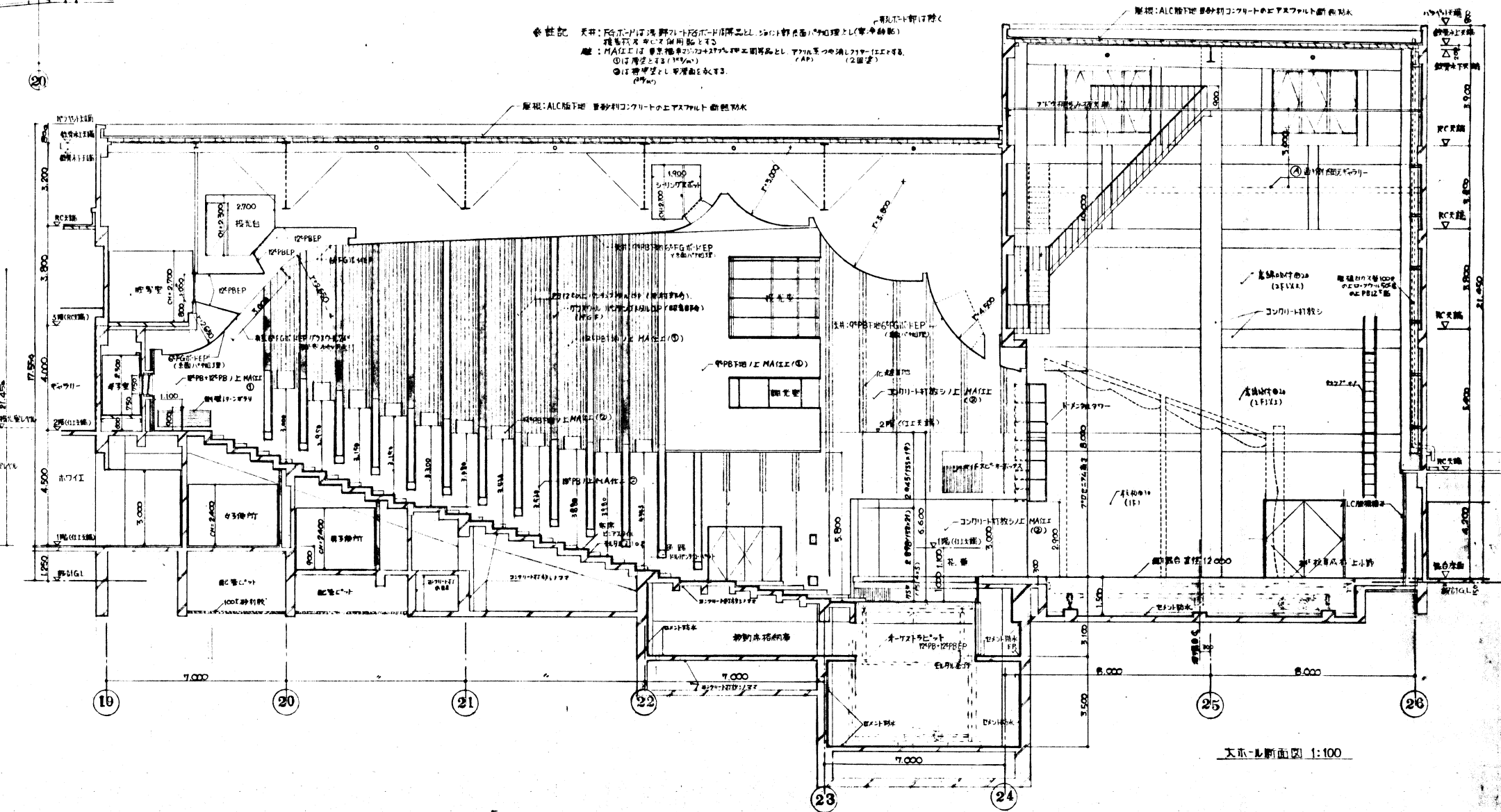

大ホール断面図 1:100

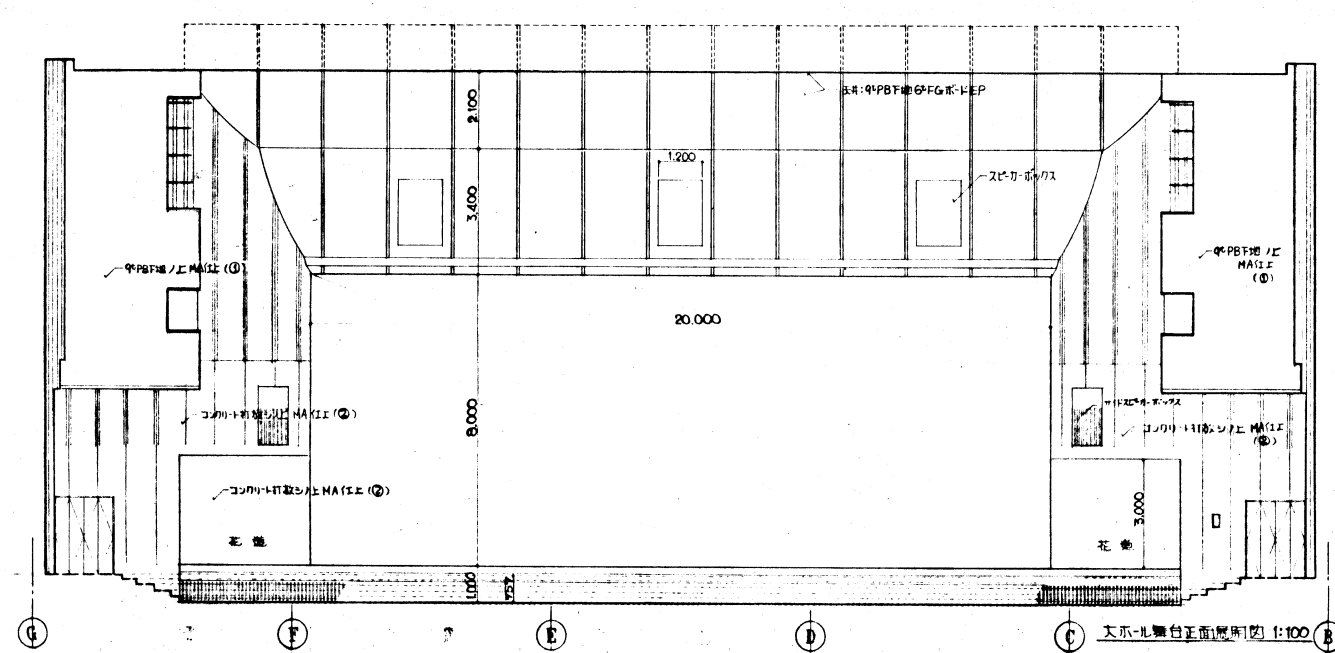

大ホール正面断面図 1:100

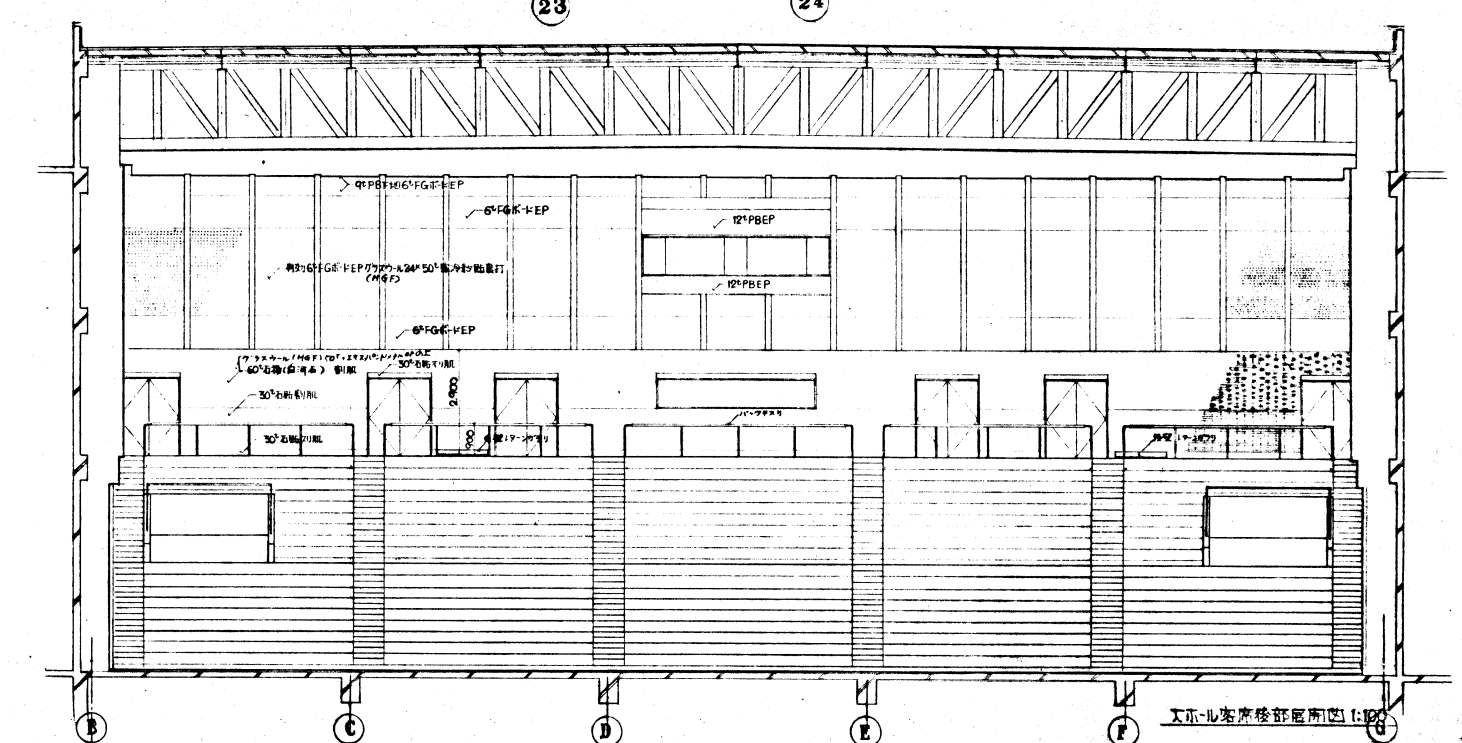

大ホール後部断面図 1:100

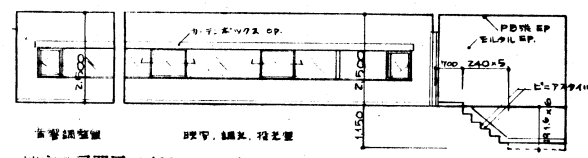

展開図 B 側

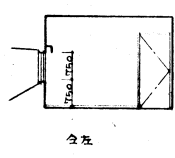

展開図 C 側

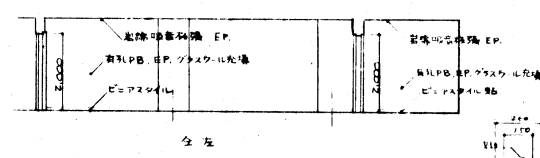

展開図 D 側

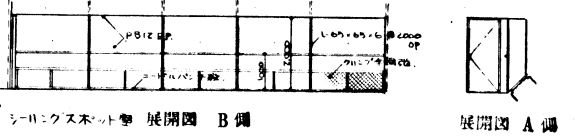

展開図 A 側

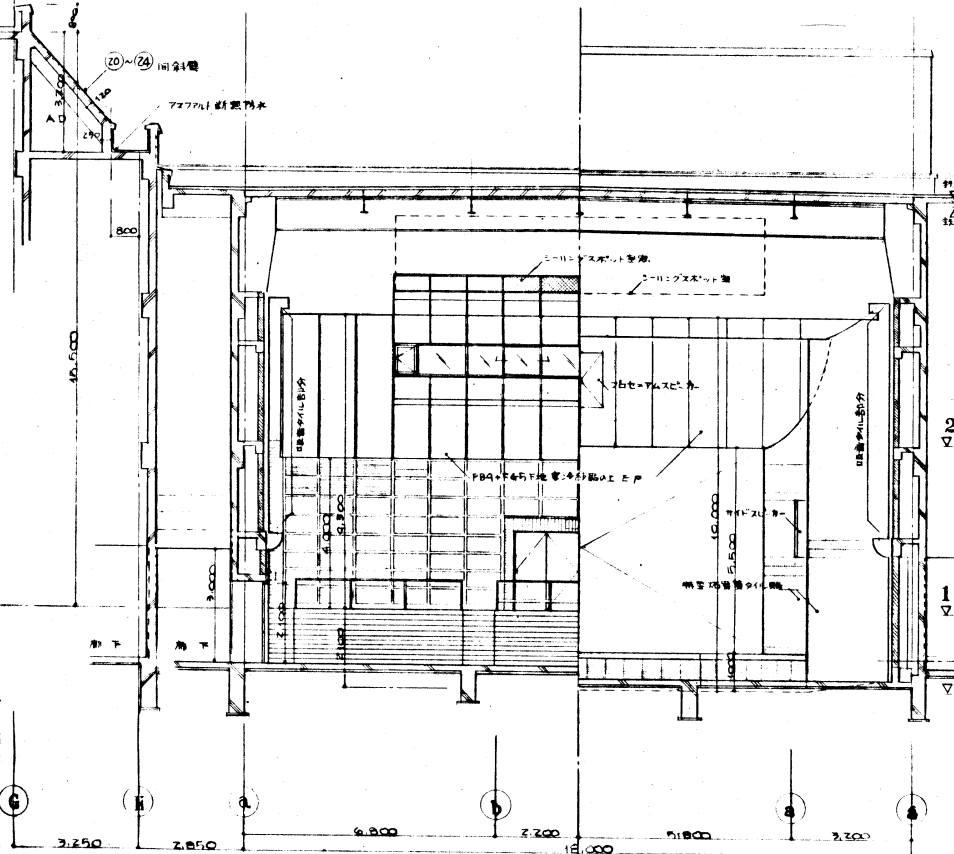

1階平面図 1:100

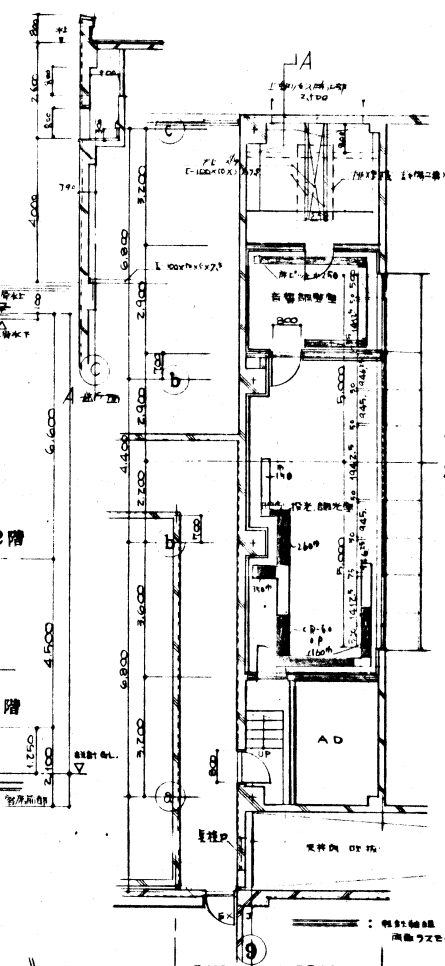

2階平面図 1:100

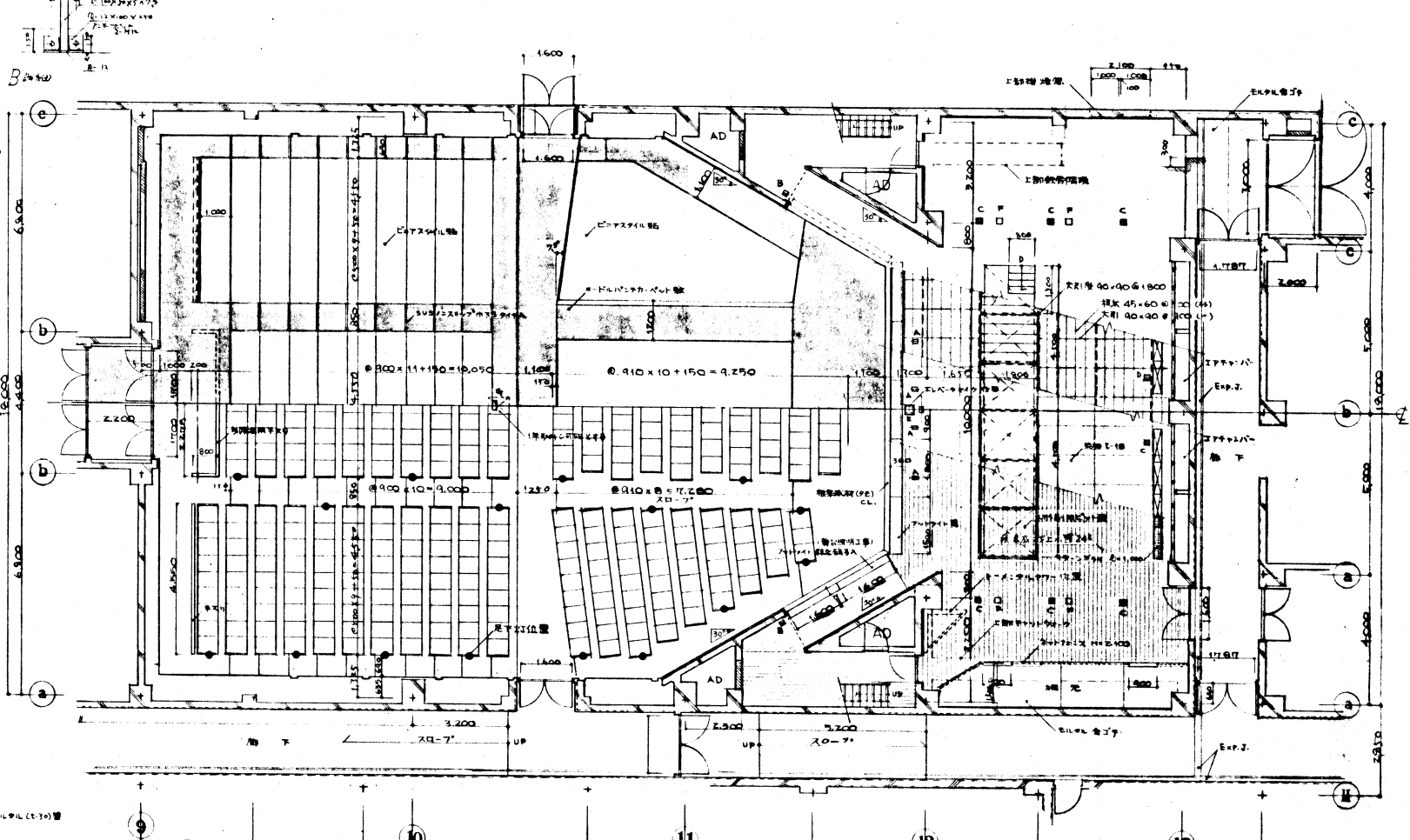

1階平面図 1:100 (足下計 計22ヶ所)

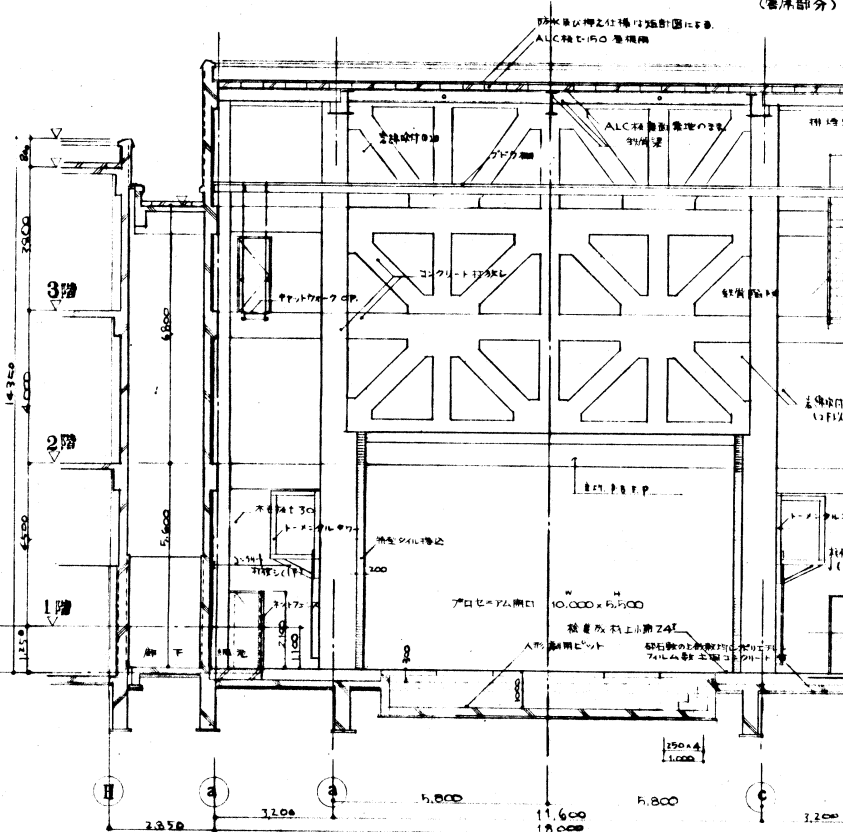

縦断面図 1:100 (欄干部分)

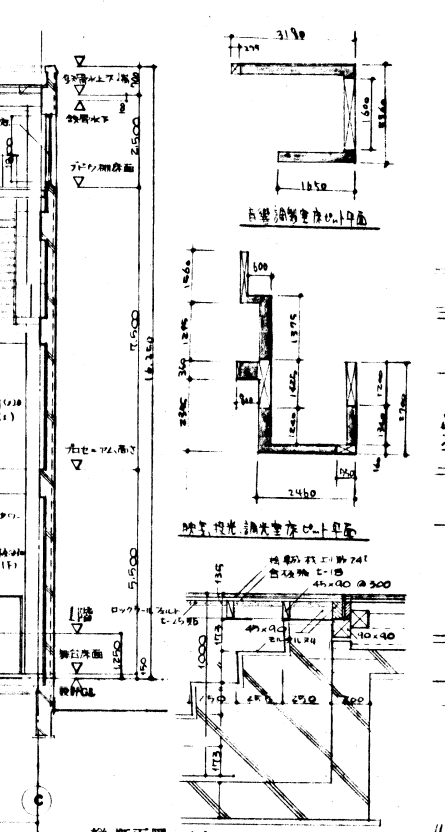

縦断面図 1:100 (欄干部分)

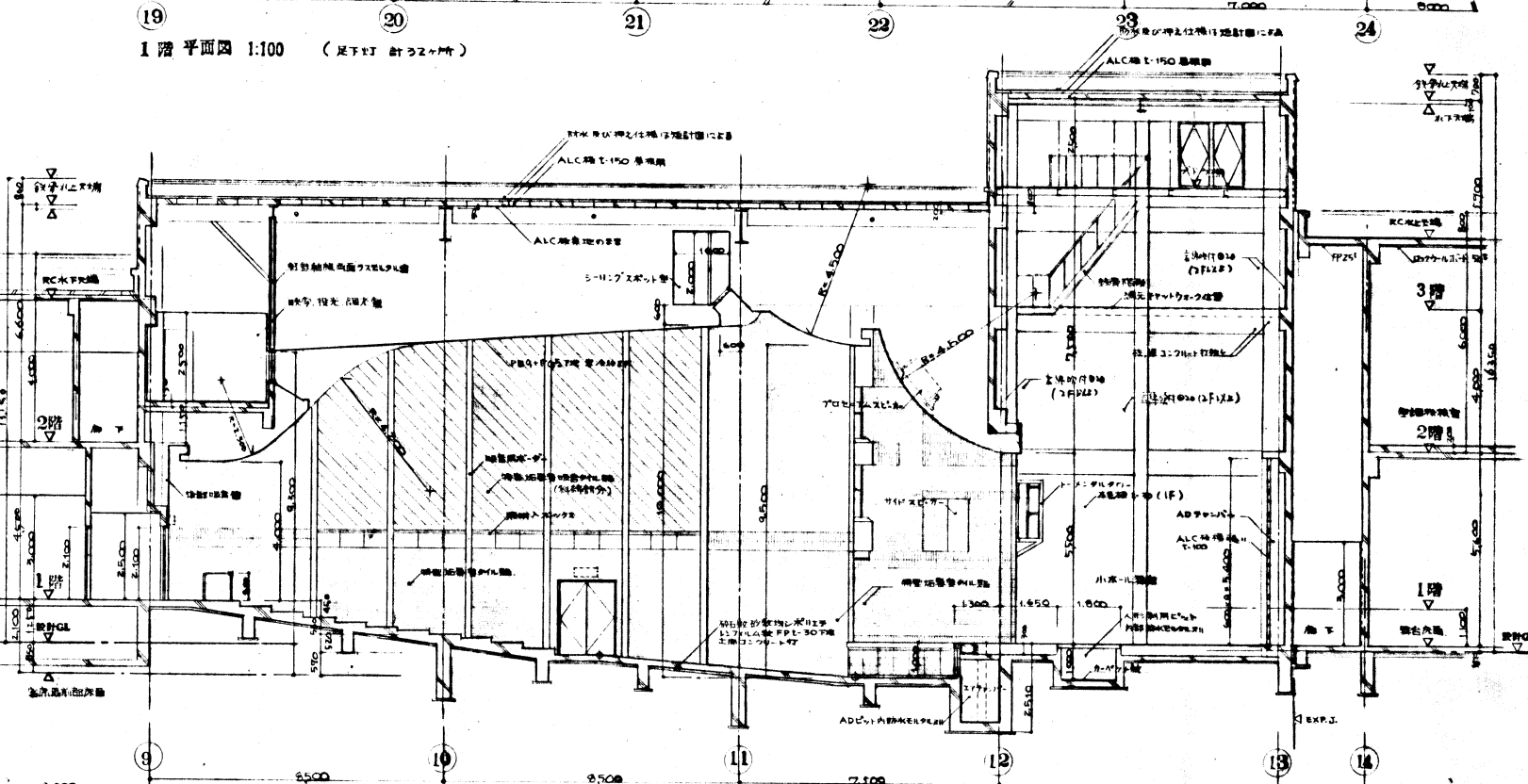

縦断面図 1:100